

SAGOLA ®



20

**BODYSHOP AND
INDUSTRIAL BODYSHOP
PROFESSIONAL EQUIPMENT**





SAGOLA can trace its origins to the year 1955 and is fruit of the pioneering spirit of its founder, Alejandro Sánchez Larrauri. It began as a small subcontracting workshop for industry. After some years in the subcontracting sector, Larrauri felt the need to manufacture his own product and progressively withdraw from subcontracted activity.

The chosen product was the spray gun. This new era for SAGOLA was crowned by the manufacture and sale of the mythical ALM 401 spray gun. From that very moment SAGOLA began to make and distribute a large number of spray gun models and other complements used in the coatings sector such as air filters, pressure pots, and an endless list of equipment for the most varied applications.

Due once again to the entrepreneurial spirit of the SAGOLA team, the need was felt to open the company to the international market. For that reason the Company began operating in related markets such as Latin America, where it soon became the indisputable leader, later expanding to Arab countries, Asia and finally Europe. Today, SAGOLA is present in more than 80 countries worldwide.

SAGOLA has maintained the highest quality standards in the manufacture of its products from its very beginnings, which has contributed to become a very important competitor in sectors such as bodyshop and industry.

Today, after 65 years, SAGOLA is still a 100% family company, a vital reason why it is a dynamic company able to adapt rapidly to changing market situations.

Nowadays SAGOLA is much more than a manufacturer of spray guns and has become a group of companies also engaged in the manufacture of aeronautic components and components for the bio-medicine sector.

Main Index

Catalogue 2020

COMPANY
Page 5/10

**PROGRAM I
BODYSHOP**
Page 11/24

**PROGRAM II
BODYSHOP**
Page 25/34

**INDUSTRIAL
BODYSHOP**
Page 35/40

AIRBRUSHING
Page 41/46

**GUIDES AND
ACCESSORIES
SPRAY GUNS**
Page 47/54

**COMPRESSED AIR
COMPLEMENTS**
Page 55/62

WASHERS
Page 64/66

INFRA-REDS
Page 67/68

**WASTE MANAGEMENT
TROLLEY AND RACKS
PERSONAL
PROTECTION**
Page 69/72

**SANDING AND
POLISHING
WORKSHOP
COMPLEMENTS**
Page 73/74

Background | Innovation | Services | Sectors | Customers | Standards |

*4600 Xtreme | 3300 GTO | Mini Xtreme |
475 XTech | Super Flow | 5000X range filters | Pack 6000X Air Heater |
Air quality test equipment | Accessories for 5000X range filters |
Water/HS finish paints • HS, Wet/Wet primers • Retouches / Spot Repair
Drying guns for waterborne products • Filtration systems inside the booth*

*3300 GTO CAR | Classic Pro XD | Classic Lux Gravity |
Junior G | 474 | Venturi Classic | 4000 range filters |
Accessories for 4000 range filters | PLUS range filters |
General Finishes • Fillers and Primers • Retouches
Drying guns for waterborne products • Filtration systems*

*Pneumatic pump complet equipments | Pressure pots |
4100 Xtreme Pressure | Mini Xtreme Pressure | 4100 Xtreme Suction |
3300 GTO Pressure |*

*XTech Airbrushes | CP1000/2000 compressors |
Premium 3800 | Airbrush complements |*

*Bodyshop application guides | Spray gun aircaps |
Nozzles and Needles for Spray Guns | Spray gun complements |*

*Product and air hoses | Plugs and Quick couplings | Threaded couplings |
3900 Plus sealers | Pneumatic undercoating guns |
Classic S1 Blowguns | Pocket blower | Classic I Plus inflating gun |*

*Compact 220 | S 25 | Compact 235 | Aqua Plastic Plus |
Doble 250 | Washer complements |*

DRY-TECH Infra-reds | Infra-reds spare parts |

*Can Crushers | Trolley and racks | 4240 face mask | MP300 mask |
FFP2 mask | Anti-static Coverall |*

L505, L252 & L252R Sanders | Paint preparation accessories |

Company

Since our beginnings, SAGOLA has always maintained the highest quality standards in its products and production processes, facilitating the most demanding coating processes.

SAGOLA began 65 years ago as a small subcontracting workshop with three workers. A strong desire to develop our own product and brand led SAGOLA to begin the manufacture of spray painting equipment.





Development and Innovation

We have 65 years of experience as manufacturer of SPRAY GUNS and spraying equipment

Market Observation and Analysis



SAGOLA specialises in the design and manufacture of coating systems

Strengthening our human resources is SAGOLA's principal objective

The high level of technology in our production methods guarantees the highest product quality standards

Since our beginnings, SAGOLA has always maintained the highest quality standards in its products and production processes, facilitating the most demanding coating processes.

SAGOLA began 65 years ago as a small subcontracting workshop with three workers. A strong desire to develop our own product and brand led SAGOLA to begin the manufacture of spray painting equipment.

- > Achieve the best technical conditions in order to offer the highest quality in the finished product,
- > and at the same time present innovation in our most demanding markets, such as the bodyshop and industrial sectors,...

All of this has made SAGOLA what it is today, a company and a brand recognised not only in the domestic market, but in more than 80 countries worldwide.

Experience

After 65 years making and developing new products, we are convinced of the need to establish a close relation with our clients on a day-to-day basis.

We know that the best product is based on the proper development of what is demanded by the market at each moment in time. For that reason we constantly reinforce our training and sales and marketing personnel, which is in permanent contact with the market and its needs all over the world.

The quality of our products is acknowledged in more than eighty countries. SAGOLA has a vast experience and owns know-how in the manufacture of professional coating systems.

Human Resources

After many years of work SAGOLA can call upon an extensive team of experts who believe in quality and innovation. These two factors are and will continue to be the pillars on which our brand is built.

SAGOLA is a worldwide benchmark brand thanks to the highly qualified professionals in our team. Notwithstanding, this team continues to work towards the objective of consolidating the SAGOLA brand as the industry yardstick.



Means of Production

The fusion of manufacturing, production means and manufacturing processes technologies with a highly qualified workforce has characterized SAGOLA from the very beginning.



**Qualifications and
 Commitment**

**Optimisation and
 Self-improvement**

Quality as a Trademark



R+D+i

Our commitment to R+D+i is absolutely clear. We devote all our efforts in this department to assuring that our products are adapted to the needs of the market.

Our objective is that between both parties and the innovations generated at our headquarters, clients will regard SAGOLA as a safe bet and stay loyal to a brand which researches on a day-to-day basis to develop products which answer their needs.

Services

When it comes to service we are talking about a deeply rooted culture arising from the history of SAGOLA, to which service is vital.

The robotic automation of all our warehouses is an example, a major investment which gives us an advantage over the competition when it comes to offering a fast, reliable response which the market appreciates.

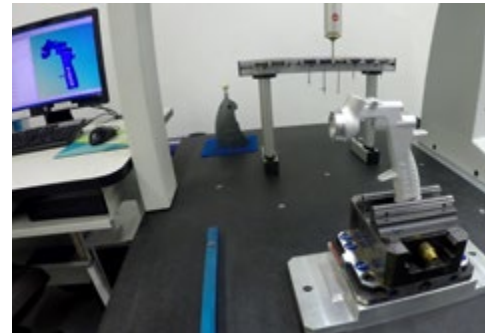

Quality

If the SAGOLA brand plays an important role on the market after 65 years of history, this is due to the emphasis placed on QUALITY.

At our factory in Vitoria (Spain), each department you visit is steeped in an atmosphere of quality.

At the beginning the founder, Alejandro Sánchez, was able to transmit this vital concept and 65 years later his heritage on this point remains as vital as on the first day.

Warranty

SAGOLA provides a 3-year guarantee with the main products. We know this is the best way of showing our customers that we believe in our products and that our guarantee will make our past and present customers loyal in the future.





From its very beginnings SAGOLA has showed marked interest in advances related to care of and respect for the environment



Support for sales networks
Our commercial office and training team are amongst the pillars of the SAGOLA BRAND worldwide



The Environment

Since the very first developments regarding VOC emissions to the atmosphere, SAGOLA wanted to be a cutting-edge company by implementing new environmental regulations and systems for its products.

With the inclusion of EPA and HVLP systems, as well as progress made in the field of filtration and others, we believe that we can contribute on a daily basis through new developments in our innovation policy.

Training

Our training team and the entire company believes that there is an important difference between being merely a quality manufacturer and being a manufacturer which develops and trains workgroups for the various sectors in which we are present.



Sales and Marketing

We believe that the products we make always need a solid sales support. Our commercial partners all over the world appreciate our assistance in setting up their sales networks and technical teams.

Thanks to the efforts of both, we embark upon each new financial year resting on a solid base suitable for the construction of a long-term project. Courses are available both at our Vitoria headquarters and on site.

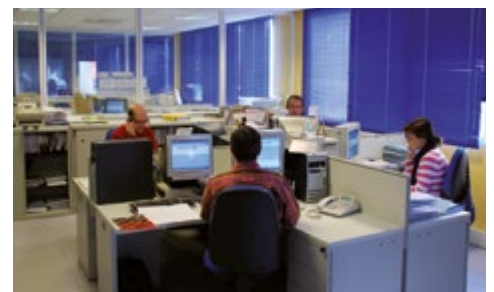

Customer Service

This department is aware that our sales effort requires its support when responding to particular dilemmas, problems or needs related to specific queries we are constantly receiving from all over the world. These are transmitted rapidly to qualified experts who provide immediate data and solutions.

**An answer
to every need**

Leading brand

**We have different
product lines specifically
adapted to the
needs of each sector**



*Bodyshop,
we set the pace*

The sectors in which we have traditionally had a presence, have always considered us a leading brand, but to stay that way all the players in each sector demand that our developments take account of the changes taking place in each field. We therefore have different product lines for each segment in accordance with its needs.

Bodyshop

This is the sector most often identified with SAGOLA, and in many ways the sector which sets the standard for all the others as far as paints and performance are concerned.

Apart from our list of annexes, for this sector we detail our star products in quality and sales volume.



Industrial Vehicle

This sector recognises in SAGOLA an established manufacturer of coating spray guns and equipment. The brand is closely associated with reliability, quality and convenience at work, contributing confidence to the commercial vehicle distribution network.

Industrial Supplies

This is a constantly developing sector in which SAGOLA has always been the reference, with special finishes, equipment, for pressure and special pumps for products specifically developed for this sector.



*Industrial Supplies,
a traditional benchmark*

International Expansion

Since August 2011, Sagola boasts a new distribution center in Mexico, which is 100% property of Sagola. This distribution center commercialize the whole range of Sagola products in Mexico.

Likewise, in 2019 the second Latin American distribution center was opened in the capital of Colombia, Bogotá.

SAGOLA MEXICO





The loyalty of our users is one of our closest allies, in conjunction with innovation.

SAGOLA has always been export-oriented and has achieved a notable expansion

Open to markets



Devoted to continuous improvement in quality, service and management

Committed to the Environment



ATEX Ex II 2 GX

Intellectual property and brand

Trademark in more than 80 countries



Our business partners are aware that SAGOLA, as well as contributing a quality brand, provides them with a manufacturer who has won their loyalty by dint of constant effort over the years. This is something we strive for every day.

We are aware that our development and innovation will be our best allies along with the loyalty of our users in the future.

Client Portfolio

We have always had an export-oriented attitude. We are currently present in more than 80 countries and keep on growing to ensure that our brand, and the products it represents, reach the entire world with the invaluable help and support of our importers.

Approved Manufacturers

Our relationship with painting manufacturers around the world means that launching SAGOLA in a new market is easier for us.

Our homologations make the market more active because users know that the product they are buying has been tested and homologated by their paint brand.

For many years, SAGOLA has devoted all its efforts not only on improving the quality of its products and service, but also to improve all aspects related with management, HR, environment, etc.

More than 60 industrial patents/models registered worldwide CEE / ASIA / USA

- Manual Spray Guns
- Automatic Spray Guns
- Packing Nuts
- Blow Guns
- Air Caps
- Valves
- Deposits
- Keys, Accessories

As a reference it is worth noting that SAGOLA was one of the first companies in Spain to obtain ISO certification, which meant a new management model where improvisation was forgotten and gave way to a management organization fully controlled and automated.

The commitment to the environment by SAGOLA has always been one of its main objectives. This is the reason why SAGOLA has been a pioneer in the manufacture of equipment for low-emission paint solvent to the atmosphere. We were pioneers in meeting environmental regulations as strict as the 1151 of the US California State SCAQMD.

On the other hand the commitment to uphold the highest standards of security makes the manufacture of our products to evolution continuously in its design and manufacturing process.

Therefore our standard products meet CE, ATEX, IP54, etc.

SAGOLA is a company which spends significant resources in R&D and is always in constant evolution. As result of this investigation and due to the need of protection of our own Know-how, SAGOLA is very active in all related with the intellectual property, being owner of a large number of patents worldwide.

Undoubtedly, SAGOLA is a recognized brand worldwide so in this aspect, the protection levels of our brand worldwide are very high. SAGOLA has got registered its different brands (SAGOLA, DEFYNIK and DELON) practically worldwide.

Bodyshop Program I

The maximum technological expression in finishing spray guns for bodyshop refinish. The widest range of solutions for the new WATER and HS paints.

Homologations from the main automotive paint manufacturers.

Ease of application in the most demanding processes. Metallic, pearls, silvers, high-gloss.

The widest range of answers for all types of professional, from the most demanding bodyshop production performance to the smallest workshop, including bodyshop coatings for industrial vehicles.

Greater reliability in the treatment of the filtrate and heating the air lines in finishes with maximum demand.

What else can you ask from the finish range of spray guns from SAGOLA?

Keep on listening to the painters' requests...





- Extreme finishes**
- Digital precision**
- Perfect waterborne paint uniformity**
- Silvers, pearls**
- The highest gloss in HS clearcoats**
- Economy in paint consumption**
- Easy and smooth handling**
- EPA XTREME and XTREME HVLP systems**
- Maximum product transfer**
- Maximum robustness and minimum maintenance**
- Ergonomics, light and equilibrated**
- PSI/BAR version (consult)**
- Maximum transfer 65 - 75 %**

SAGOLA presents its top technological expression in bodywork finishing spray guns. Smaller, lighter, with optimal weight distribution and more comfortable.

With a new shiny and modern design and most carefully designed ergonomics which offer enviable balance and usability and perfect mechanisation. SAGOLA tackles all present challenges of vehicle refinishing.

With this model SAGOLA offers the widest range of solutions for all the new paints launched by the main paint brands for refinishing.

The New 4600 Xtreme is launched with the highest SAGOLA manufacturing standards, competitive prices whilst maintaining a superb service and offering the best warrantee (3 years). All this with strict compliance with the most demanding standards of manufacture and emissions of solvents, with XTREME and XTREME HVLP systems.

The **DVR AQUA** and **DVR HVLP** aircaps enhance the application of waterborne products, regardless the level of viscosity. Even distribution of paint through the spray pattern.

TECHNICAL DETAILS

- > Weight without cup: (digital): 494 g
- > Weight without cup: (internal reg.): 482 g
- > Weight with cup: (digital): 680 g
- > Weight with cup: (internal reg.): 668 g
- > Dimensions with cup:
 - Digital: 36,5 x 10,6 x 17cm
 - Internal regulator: 33,5 x 10,6 x 17cm
- > Air inlet couplings: 1/4"
- > Cup capacity: 650 ml
- > Cup with removable anti-drip system
- > Incorporates 80-mesh paint filter
- > Maximum recommended inlet pressure (working pressure): 2 bar
- > Maximum recommended application distance:
 - DVR TITANIA, DVR CLEAR, DVR AQUA: 18 - 20 cm
 - LXT HVLP: 12 - 15 cm
- > Average paint output flow (nozzle 1.4 mm. 20"):
 - DVR TITANIA: 233 g/min
 - DVR CLEAR: 227 g/min
 - DVR HVLP: 210 g/min
 - DVR AQUA: 239 g/min
- > Air consumption of each aircap (2 bar inlet):
 - DVR TITANIA: 315 L/min
 - DVR CLEAR: 295 L/min
 - DVR HVLP: 450 L/min
 - DVR AQUA: 280 L/min
- > Fan size:
 - DVR TITANIA: 265-285 mm
 - DVR CLEAR: 285-300 mm
 - DVR HVLP: 280-300 mm
 - DVR AQUA: 295-300 mm
- > Average sound pressure level: 80 dB
- > Materials in contact with the product: anodized aluminium, POM, INOX, Teflon and Nylon
- > Battery type (digital): CR-1/3N Li-Mn 3 V



DVR TITANIA
multiproduct

Lacquers, clearcoats, basecoats



DVR CLEAR
HS

Top performance and gloss with clearcoats and single stage HS paints



DVR AQUA
waterborne

Special waterborne products, easy to apply even at high viscosities



DVR HVLP
colour

Minimum mist, maximum savings and perfect colour matching



- WATERBORNE
- METALLICS
- SILVERS
- PEARL COATINGS

- LACQUERS
- CLEARCOATS
- SINGLE STAGE PAINTS
- MS and HS



The aircap **DVR CLEAR** together with the **innovative nozzle 1.3XL** means a milestone at the ease and speed of application with the new HS clearcoats.

REGULATIONS / PATENTS / REGISTRIES

All SAGOLA products comply with the strictest safety standards for the manufacturing of painting equipment. SAGOLA products comply with **EC regulations** and all the **ATEX standards**. To protect itself against copies and counterfeits, SAGOLA register the shape of its guns and, naturally, registers its trademark worldwide.

4600 Xtreme



Promotional video
 Sagola 4600 Xtreme

The most complete range of solutions for the car refinish

Approved by the main paint brands

Compliance with the strictest regulations concerning emissions of solvents



Tester 4600 HVLP

Pressure checker for 4600 XTREME HVLP aircaps.
 See page 52



Digital version

Standard version
 (internal regulator)

DESIGN, FINISH, SHEEN

The new image of polished forged anodized aluminium recovers the original sheen and COLOUR from SAGOLA bodywork with a MODERN DESIGN.

At the forefront of ergonomics, balanced and comfort when painting.

LIGHT and ROBUST, maintaining the construction in forged aluminium and stainless steel in all its pieces, giving it maximum robustness and minimum maintenance.

Easy and smooth use.

ECONOMIC CONSUMPTION OF PAINT

HVLP aircaps with maximum savings and minimum mist.

EPA aircaps with maximum performance regarding time and ease of application

THE WIDEST RANGE OF SOLUTIONS

Perfect COLOUR MATCHING with basecoats. The highest performance and gloss with clearcoats and HS single stage paints.

2 models: DIGITAL and internal air regulator.

4 aircaps: to fit each need, offering the highest performance and lowest air consumption in their category.

New special nozzle for HS clearcoats, the innovative 1.3 XL.



RC1
Air Flow Regulation
with Pressure Gauge
Manual Tightening

Ideal to work with high transfer spray guns HVLP and EPA. Pressure scale red-green as the regulation demands. Made of aluminium.

Very light.
 See page 52



7 INNOVATIVE ADVANTAGES

- 1 NEW NOZZLES DV.** Made of stainless steel. High paint flow. Maximum speed of application. 15 - 20% higher product transfer.
- 2 NEW ALUMINUM AIRCAPS for HS and WATERBORNE.** DVR AQUA - DVR CLEAR - DVR HVLP - DVR TITANIA identified with different colors (COLOR SYSTEM). Ultra-fine paint particle size and bigger spray patterns. In the case of the hybrid ones they get higher transfer and greater efficiency, close to the maximum save of HVLP, with better spraying control. Efficient and safe for solvent or waterborne basecoat. Fast with clearcoat.
- 3 NEW AND REVOLUTIONARY AIR DISTRIBUTION SYSTEM.** Carried out at the tip of the air cap, it creates a finer and smoother spray. P 08380132.4
- 4 NEW PROGRESSIVE ACTION VALVE "SOFT FLOW".** Higher precision and smoothness, even with high air pressure.
- 5 NEW PRODUCT REGULATOR DESIGN.** Modern design without sharp edges, it makes easier cleaning. New stainless steel guide box. Built in vernier for precise flow regulation.
- 6 NEW SPRAY FAN REGULATOR DESIGN.** Modern design without sharp edges, it makes easier cleaning. With connection in stainless steel. With less travel and greater precision. Suitable for right and left handed.
- 7 NEW COLOR IDENTIFIER (COLOR CODE).** Perfect for differentiation spray guns when there are multiple painters.
- 8 BODY in highly resistant ANODIZED FORGED ALUMINIUM.** REGISTER DC 3.300.029
- 9 AT THE VANGUARD OF TECHNOLOGY "METAL TO METAL".** The high-end mechanisation technology used makes it the only spray gun in the bodywork market that is manufactured without any kind of gasket, interior or exterior, at the closures between the air and paint. **Minimum number of spare parts.**
- 10 One single piece AUTOMATIC PAINT PACKING GLAND.** Unique in the market. It avoids manipulation and breakage of the glands and makes easier to remove it for a through cleaning of the paint part. P 073000321.5
- 11 ERGONOMIC DESIGN OF THE HANDLE.** Rounder, more ergonomic and comfortable. Enables perfectly balanced movements while painting.
- 12 ERGONOMIC AND CONFORTABLE TRIGGER** New design, reduces fatigue. 100% stainless steel. New screw and saft in stainless steel.
- 13 DIGITAL PRESSURE GAUGE** High-precision pressure readings. Protective ring in stainless steel. Complies with ATEX regulations Ex II 2G Ex ia IIC T4 Gb / CE 0163 LOM 05ATEX 2091X.
- 14 HIGH-PRECISION AIR FLOW REGULATOR** Modern design without sharp edges, it makes easier cleaning. Higher regulation precision. Avoids working loose unwittingly.
- 15 Hand tightened AIR FLOW REGULATOR WITH PRESSURE GAUGE.** It does not need any tool to be set or removed. Unique in the market. High precision progressive adjustment. P 200100036

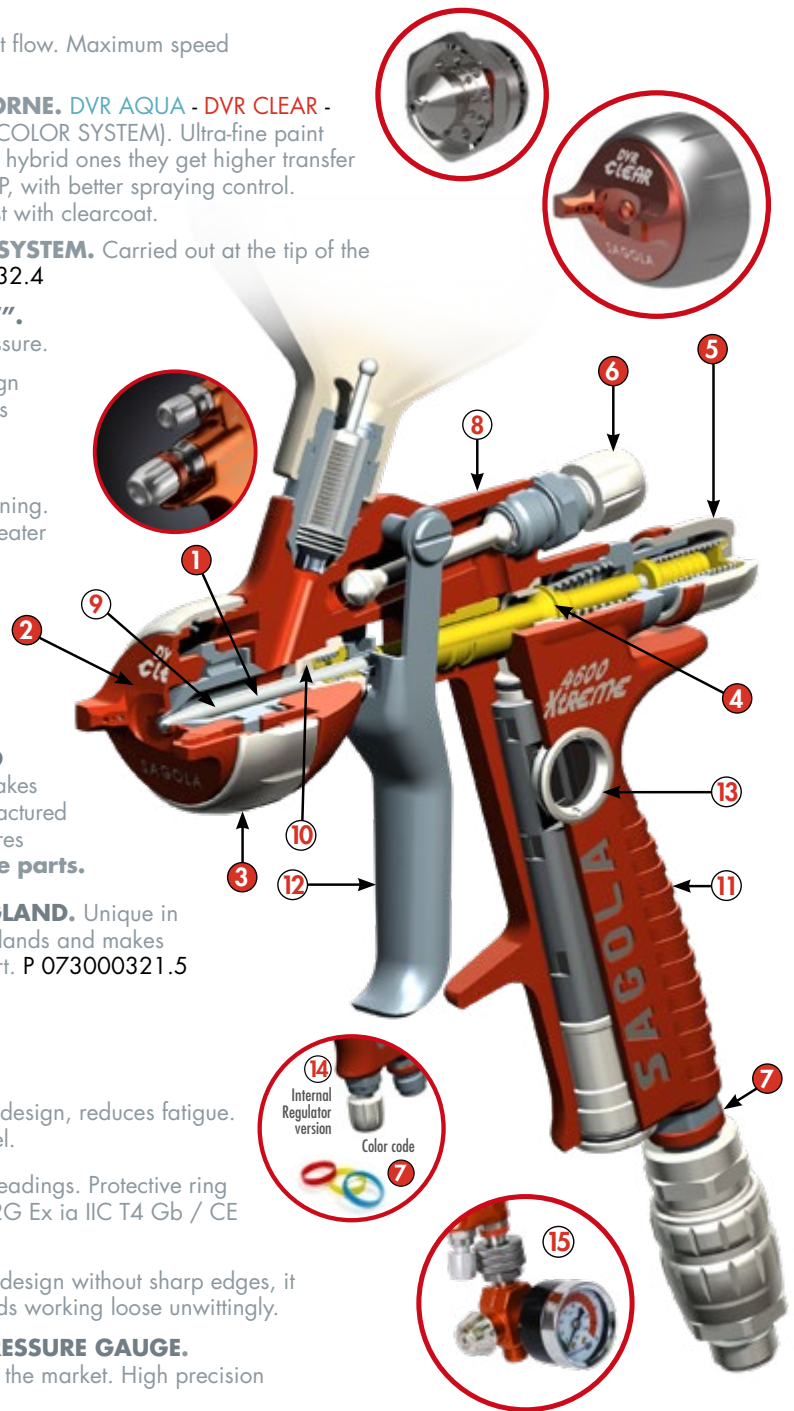

4600 Xtreme



Version	Application	Pressure recommended
1.20	Clearcoats. Express drying	2 -2.2 bar
1.20XL	Clearcoats. Express drying	2 -2.2 bar
1.30	Single Stage	2 -2.2 bar
1.30 XL	Single Stage	2 -2.5 bar



Version	Application	Pressure recommended
1.20	Clearcoats. Express drying	2 -2.2 bar
1.20XL	Clearcoats. Express drying	2 -2.2 bar
1.30	HS & UHS Clearcoats, Single Stage	2 -2.2 bar
1.30 XL	HS & UHS Clearcoats, Single Stage	2 -2.2 bar
1.40	HS & UHS Clearcoats, Single Stage, Industrial bodyshop	2 -2.2 bar



Version	Application	Pressure recommended
1.20	Waterborne paints and solvent basecoat	1.5 -2 bar
1.20XL	Waterborne paints and solvent basecoat	1.5 -2 bar
1.30	Waterborne paints and solvent basecoat	1.5 -2 bar



Version	Application	Pressure recommended
1.20	Waterborne paints and solvent basecoat	1.8 -2 bar
1.30	Waterborne paints and solvent basecoat	1.8 -2 bar
1.30XL	Waterborne paints and solvent basecoat	1.8 -2 bar

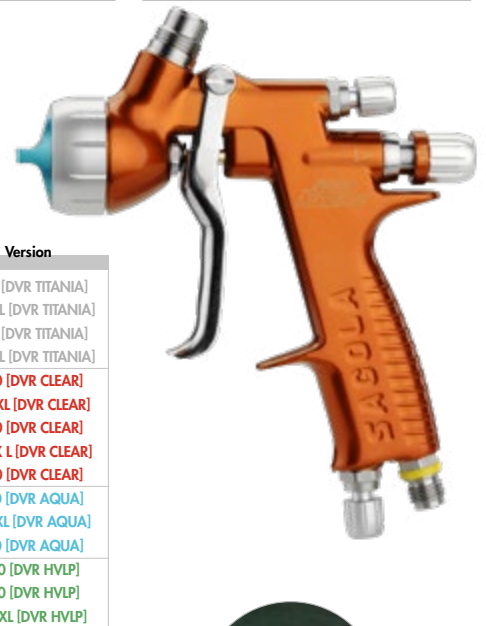

Code	Version
10142236	1.20 [DVR TITANIA]
10142233	1.20XL [DVR TITANIA]
10142222	1.30 [DVR TITANIA]
10142227	1.30XL [DVR TITANIA]
10142237	1.20 [DVR CLEAR]
10142235	1.20XL [DVR CLEAR]
10142224	1.30 [DVR CLEAR]
10142226	1.30XL [DVR CLEAR]
10142231	1.40 [DVR CLEAR]
10142221	1.20 [DVR AQUA]
10142234	1.20XL [DVR AQUA]
10142223	1.30 [DVR AQUA]
10142239	1.20 [DVR HVLP]
10142225	1.30 [DVR HVLP]
10142238	1.30XL [DVR HVLP]

Code	Version
10142217	1.20 [DVR TITANIA]
10142214	1.20XL [DVR TITANIA]
10142202	1.30 [DVR TITANIA]
10142207	1.30XL [DVR TITANIA]
10142218	1.20 [DVR CLEAR]
10142216	1.20XL [DVR CLEAR]
10142204	1.30 [DVR CLEAR]
10142206	1.30XL [DVR CLEAR]
10142212	1.40 [DVR CLEAR]
10142201	1.20 [DVR AQUA]
10142215	1.20XL [DVR AQUA]
10142203	1.30 [DVR AQUA]
10142219	1.20 [DVR HVLP]
10142205	1.30 [DVR HVLP]
10142209	1.30XL [DVR HVLP]



REGULATIONS / PATENTS / REGISTRIES

All SAGOLA products comply with the strictest safety standards for the manufacturing of painting equipment. SAGOLA products comply with EC regulations and all the ATEX standards. To protect itself against copies and counterfeits, SAGOLA register the shape of its guns and, naturally, registers its trademark worldwide.

	Industrial model	Patent	4600	4600 Digital
Paint packing		07380321.5		
Digital gauge	559.018			
Shape design	3.300.029			
Aircaps with air deflector		08380132.4		
ATEX	Ⓢ II 2G Ex ia IIC T4 Gb CE 0163 LOM 05ATEX 2091 X			
	Ⓢ II 2G T60°C x			



Couplings for disposable deposits PPS
 See page 54

REGULATIONS

- CE
- EN 1953
- ATEX Ⓢ II 2G T60°C X
- ATEX Ⓢ II 2G Ex ia IIC T4 Gb

3300 GTO Gravity



3300 GTO

New body, lighter,
 maximum ergonomics

EPA and HVLP systems

Time saving. Product saving

Top-range and Low
 consumption High-end
 Aluminium aircaps

Compliance with the strictest
 regulations concerning
 solvent emissions

HS Primers / Wet-wet

Its new forged body and more ergonomic design together with the highest quality and efficiency nozzles (high transfer), make a more attractive and versatile spray gun with an excellent value for money offering a wide range of solutions for different painting applications.

SAGOLA renews and improves the mid-high range of spray guns. The new 3300 GTO, is the result of the fusion of two of the most renowned products: 3300 PRO y 4100 GTO.



Perfect atomization with
 minimum overspray

Masking and sanding
 time savings

TECHNICAL DETAILS

- > Weight without deposit: 423 g
- > Dimensions with cup: 34.5 x 10 x 18 cm
- > Air inlet couplings: 1/4"
- > Cup capacity: 650 ml
- > Cup with removable anti-drip system
- > Design pressure: 8 bar
- > Maximum recommended inlet pressure (working pressure): 2 bar
- > Maximum recommended application distance:
 3300 EPA: 15 - 18 cm
 3300 HVLP: 12 - 15 cm
- > Maximum paint flow output (1.4 mm. nozzle 20"):
 3300 EPA: 179 g/min
 3300 HVLP: 145 g/min
 3300 EVO: 179 g/min
- > Air consumption (2 bar inlet):
 3300 EPA: 235 L/min
 3300 HVLP: 365 L/min
 3300 EVO: 255 L/min
- > Fun size:
 3300 EPA [1.8]: 250 mm.
 3300 HVLP [1.8]: 250 mm.
 3300 EVO [1.4]: 280 mm.
- > Average sound pressure level: 80 dB
- > Materials in contact with product:
 chromed aluminium, anodized aluminium,
 POM, INOX and Teflon.



Code	Version	Application
10141562	1.40 [EPA]	Primers
10141563	1.60 [EPA]	Refinish Primers. Drying express
10141564	1.80 [EPA]	HS Primers
10141572	2.20 [64S]	High-thickness Primers
10141574	2.80 [62S]	Spray gun Fillers
10141555	1.40 [HVLP]	Primers
10141556	1.60 [HVLP]	Refinish Primers. Drying express
10141557	1.80 [HVLP]	HS Primers
10141559	1.30 [EVO]	Wet/Wet Primers
10141560	1.40 [EVO]	

REGULATIONS / PATENTS / REGISTRATIONS

SAGOLA registers the shapes of its guns and its brand/trademark worldwide, and complies with the strictest safety standards and with the strictest standards on solvent emissions:

- > CE
- > EN 1953
- > ATEX II 2G T60°C X
- > SQMDA 1151 CALIFORNIA
- > SQMDA 1136 CALIFORNIA

BODYSHOP Program I Fillers and Primers

3300 GTO Gravity



New Regulators

Air Flow, paint flow and fan control redesigned

Improved balance

Reworked distribution of material, reinforcing the critical areas



Nozzle and needle

Made of stainless steel

Aircaps

Ultra-fine atomization and larger fans. Designed for the best response at any pressure



Ergonomic trigger

Made of stainless steel
It reduces fatigue



Single axis system

Inherited directly from the Xtreme range, simplified design, synchronized operation in any circumstance. Maximum reduction of components and maintenance



One single piece automatic paint packing gland

It avoids manipulation and breakage of the glands and makes easier to remove it for a thorough cleaning of the paint area



Body anodized forged aluminium

High quality and resistance

Soft Touch finish

Soft and silky touch. Satin finish

Anti-corrosive protection

Easier for cleaning and maintenance process



Couplings for disposable deposits PPS

See page 54



Mini Xtreme Gravity

Mini Xtreme

Spot Repair

Designed for quick repair processes especially with waterborne paints

Ideal for part painting

High quality finishes

Made of forged aluminium



Control, this is the word that best defines the new SAGOLA Mini Xtreme; why run risks using the wrong tool when it does exist a tool that eases what is difficult?

It always assures the perfect paint-air relation in each situation. It works with the right fan size avoiding the risk of overcharge and inappropriate drop-size.

It reduces mist, saves paint, and perfectly defines the work area.

Light, ergonomic, strong and adapted to the last technologies. Tested and developed on waterborne products.

The fans are designed to obtain the best drying time with the best finish, and always with minimum pressures between 0.5 - 1.0 bar.



Mini Xtreme Gravity
 500 ml. deposit capacity



Couplings for disposable deposits PPS
 See page 54



Mini Xtreme Gravity
 125 ml. deposit capacity

TECHNICAL DETAILS

- > Weight without deposit: 350 g
- > Dimensions with deposit: 26 x 16 x 7 cm
- > Air inlet couplings: 1/4"
- > Standard deposit capacity: 125 ml
- > Incorporates 100-mesh paint filter
- > Design pressure: 8 bar
- > Maximum recommended inlet pressure (working pressure): 2 bar
- > Maximum recommended application distance: 15 - 18 cm
- > Maximum paint flow output (nozzle 1.0, viscosity 16"):
 - Mini AQUA: 102 g/min
 - Mini HVLP: 92 g/min
 - Mini TECH: 116 g/min
- > Air consumption (2 bar inlet):
 - Mini AQUA/EPA: 190 L/min
 - Mini HVLP: 325 L/min
 - Mini TECH: 52 L/min
- > Fan size:
 - Mini AQUA: 235 - 250 mm.
 - Mini HVLP: 170 - 210 mm.
 - Mini TECH: 50 - 60 mm.
- > Average sound pressure level: 81dB
- > Materials in contact with product: anodized aluminium, POM, INOX, Teflón and Nylon.

Code	Version	Application
10111801	0.80 [MiniAQUA]	Special for waterborne paints. Xtreme finishes
10111802	1.00 [MiniAQUA]	Waterborne paints
10111803	1.20 [MiniAQUA]	Waterborne paints. Ultra violet paints (Opaque deposit)
10111809	1.00 [MiniHVLP]	Fine shadings
10111810	1.20 [MiniHVLP]	Retouching, feathering. Waterborne/solvent basecoat. Clearcoats
10111804	1.30 [MiniHVLP]*	Waterborne and solvent based basecoats
10111806	0.80 [MiniEPA]*	Retouching, feathering. Waterborne/solvent basecoat. Clearcoats
10111807	1.00 [MiniEPA]*	Clearcoats and dyes. Retouching and feathering
10111808	1.20 [MiniEPA]*	Clearcoats. Extremely high quality finishes
10111811	0.60 [MiniTECH]*	Low viscosity products. Lettering and small retouches

(*) 500 ml. cup capacity



**Precision solutions for
tiny details and retouches**

Very high quality of spray

**Very light
injected-aluminium body**

Code	Version
20140801	0.50 [05]
20140802	0.80 [05]
20140803	1.00 [10]
20140804	0.50 [R5]



**Drying gun for
waterborne products**

Reduction of drying time

**Greater volume of air output
making possible the fast
evaporation of water**

Exclusive Venturi regulator

Code	Version
10340401	Super Flow

Code	Version
40000243	Venturi classic Stand

Exclusive system of STRIPPING DOWN for cleaning
(in the event of pollution)



Gravity Spray gun that due to its reduced dimension becomes ideal for shadings, little retouches and/or painting of small parts. It includes a 125 c.c. high quality deposit and paint filter.

Large variety of nozzles and solutions



Aircap R5

Special aircap R5: to obtain the Maximum precision at the tiniest feathering. Definition and regulation.

Similar to an airbrush. Nozzles of 0.5 mm.

Aircap 05: High quality spray at feathering and retouches Nozzles of 0.5 and 0.8 mm.

Aircap 10: quick and versatile. Metals and clearcoats. Nozzles of 1.0 mm.

TECHNICAL DETAILS

- > Weight with deposit: 330 g
- > Air inlet coupling 1/4" male
- > Design pressure: 8 bar
- > It incorporates a 100-mesh paint filter
- > Maximum recommended inlet pressure (working pressure): 2.0 - 3.0 bar
- > Air consumption (3.0 bar inlet):
Aircap 05: 100 L/min
Aircap 10: 110 L/min
Aircap R5: 45 L/min



Catalogue 2020

BODYSHOP Program I Retouches part painting

475 XTech



475
XTECH

Super Flow | Drying for waterborne products

Special drying gun for waterborne products.

Includes venturi regulator to adapt drying technique to the coated surface, retouched area or entire part.

Achieves far superior performance than any other waterborne paints dryer.

Can be fully dismantled to facilitate cleaning and proper maintenance (avoiding pollution).

TECHNICAL DETAILS

- > Weight: 580 g
- > 1/4" M Air Inlet
- > Design pressure: 12 bar
- > Working pressure: 3 - 6 bar
- > Sound level: 80 to 83 db
- > Maximum air flow
- > Up to 6,000 litres of air per minute
- > Stainless steel air filter
- > Air consumption: 300 - 600 L/min

Maximum air quality

Minimal loss of pressure in line

Developed for new automotive paint technologies

The air from a compressor which is circulating throughout the line contains particles and solid impurities, water from the relative humidity of the suctioned air and burnt oil from the compressor.

That's why it is necessary to eliminate these impurities with the help of a filter but taking into account that we always have to obtain the maximum performance with the minimum pressure loss.

With the recent emergence of the new regulations concerning the drastic decrease of solvents in the new primers, basecoats, HS clearcoats and

even in the waterborne paints, the existence of impurities in the compressed air which is used to spray is now more critical for the final results of the bodywork, mainly due to:

- **In HS:** the high gloss of these paints, their poor proportion of solvents and their decrease in the number of finishing coats make that the small particles proceeding from the compressed air become striking.

- **In waterborne paints:** their high incompatibility with any oil and organic fumes makes the air quality requirements very high.

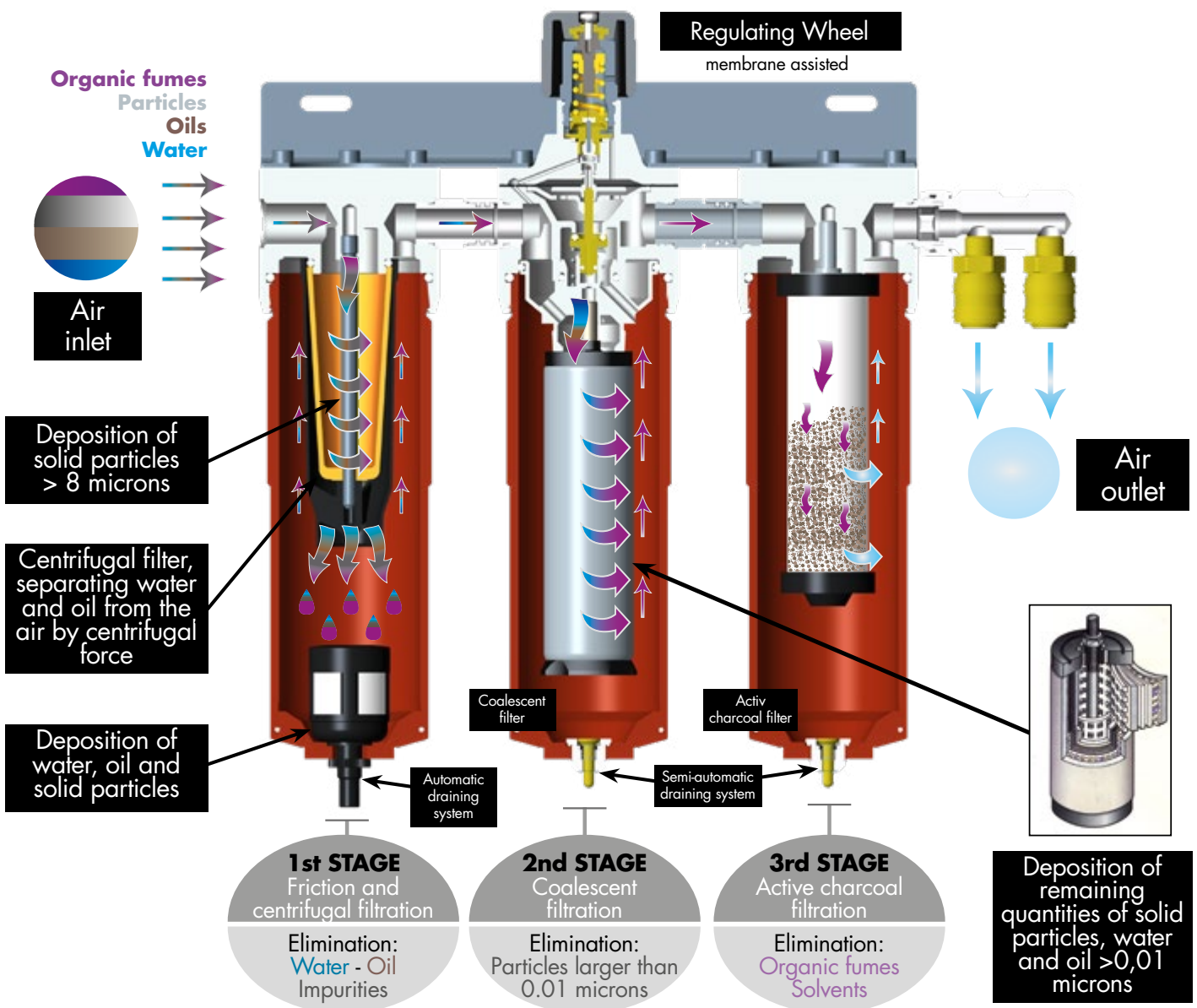

Filters 5300X / 5300X+ / 5200X



Coalescent Filter Regulator Purifier Filter (0.01 microns) + wide surface active charcoal

Ideal for waterborne and HS paints

Solutions for lines with organic fumes in the network

Very high quality finishes

Minimum loss of pressure

Double outlet



5300X+

Model	Code	Version
5300X	10730305	US-Mil
	10730351	Nitto
	10730308	Euro-profile

Model	Code	Version
5300X+	10730306	US-Mil
	10730310	Nitto
	10730309	Euro-profile

Model	Code	Version
5200X	10730304	US-Mil
	10730350	Nitto
	10730307	Euro-profile

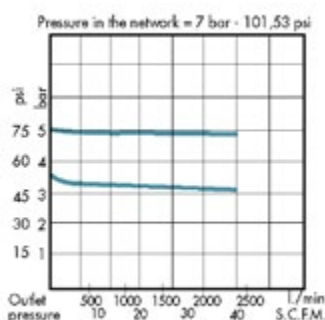

5300X



5300X

Model 5300X offers the maximum filtration level in spray booths and painting lines with high quality air demand.

Ideal for waterborne paint and where organic fumes in the network are a problem.

Sinterised brass **8 micron** pre-filtration is incorporated, followed by a **0.01 micron** coalescent filter and final filtration by a **wide surface active charcoal filter**.

In addition to water and impurities, this process eliminates organic fumes and foul air.

5300X +

Similar technical and mechanical characteristics than in 5300X.

Ready for an independent use of the Filtration with Active Charcoal.

Double outlet of the Coalescent Filter for the painting and/or blowing.

Simple outlet of the Active Charcoal Filter for the Breathing Equipment or painting.

5200X

Model 5200X offers the highest technology for air filtration.

It incorporates an **8 micron** sinterised brass filter, followed by a final **0.01 micron** coalescent filter. Other characteristics are the automatic drain system and the regulator with regulation wheel.

Its **NEW VESSELS** are tougher and more protective. Its **NEW DRAINING SYSTEM** reduces maintenance costs due to its greater durability. It carries out double filtration with optimum flow and pressure regulation, retention of water and impurities attaining an air purity of 99%.

5200X



Wide surface filtration elements

Maximum quality of manufacturing processes

Materials and mechanization

Special for waterborne and HS paints

Maximum flow 2,500 L/min

Very smooth working

Maximum precision

Maximum air filtration quality

Quick couplings with mechanisms made of stainless steel

Silicone free joints

TECHNICAL DETAILS

5300X/5200X Models

- > Air flow: 2,500 L/min
- > Air inlet: 1/2" BSP
- > Air outlet: 1/4" BSP
- > Maximum working pressure: 12 bar
- > Maximum temperature resistance 90°C
- > Automatic + semi-automatic drain system (5200X)
- > Automatic + 2 semi-automatic drain systems (5300X)



5100X / 5000X / 5050X filters

Valid for HS paints and high quality finishes

Air filtration regulator with new vessel and new drain system

Minimum pressure loss

Double outlet (5100X, 5000X)

5100X

Model	Code	Version
5100X	10730202	US-Mil
	10730208	Nitto
	10730206	Euro-profile

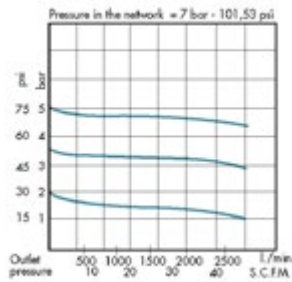

5100X



5000X

5050X



Air-assisted regulation wheel (5100X)

Wide surface filtration elements

Maximum quality of manufacturing processes, materials and mechanization

Maximum flow 2,500 L/min.

Very smooth working

Maximum precision

Maximum air filtration quality

Quick couplings with mechanisms made of stainless steel

Silicone free joints

Automatic drain system (5100X, 5050X)

5050X

Model	Code	Version
5050X	10720301	US-Mil
	10720303	Nitto
	10720302	Euro-profile

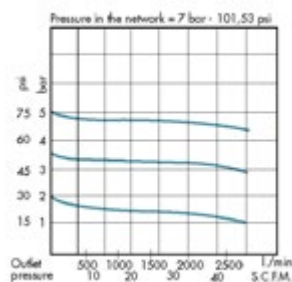

5100X

Air purifying filters with pressure regulator and assisted regulator wheel.

Its **NEW VESSEL** is tougher and more protective Model 5100X comes with a **NEW DRAIN SYSTEM** which reduces maintenance costs due to its greater durability. Its triple filtration system retains water and impurities. It incorporates an **8 microns** sinterised brass filter.

5050X

Model 5050X is an air purifying filter, ideal for the pre-filtration in industrial air lines.

Line Pre-filter for: outlet of medium compressor (inlet 1/2"), level changes in the network, inlet to booths,...

5000X

Model	Code	Version
5000X	10730204	US-Mil
	10730207	Nitto
	10730205	Euro-profile

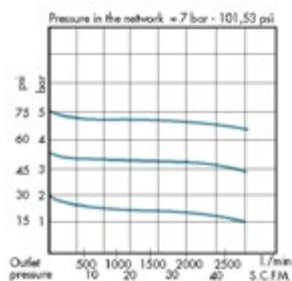

5000X

Air purifying system with regulator, with an excellent price/quality ratio. Ideal for booths working with solvent-based paints and preparation areas.

Model 5000X incorporates a semi-automatic drain system and double outlet.

Its **NEW VESSEL** is tougher and more protective.

TECHNICAL DETAILS

- > Air flow: 2,500 L/min
- > Air inlet: 1/2" BSP
- > Air outlet: 1/4" BSP (USMil connectors)
- > Maximum working pressure: 12 bar
- > Maximum temperature resistance 90°C
- > Semi-automatic drain system (5000X)
- > Automatic drain system (5100X, 5050X)



Pack 6000X Air Heater

PACK
6000X
AIR HEATER

REDUCTION of drying times

BETTER stretching of clearcoats

SAFE and regular work all the year around

Self-learning function

Overheating protection

Automatic activation by flow switch

Low temperature, there is no need for gloves

In the new **PACK 6000X AIR HEATER** compact design, innovation, electronic high technology and ease of use come together and assure the **temperature stability** both in the compressed air and the final painting elements such as hose and spray gun.

- > Stable painting process in areas with large temperature changes between day and night, winter and summer.
- > Constant working temperature.
- > Compact and robust.
- > Digital temperature display.
- > Cold touch, thermal insulation.

Easy to use; power button and temperature controller. Out of the cabin installation. Lightweight and small; easy to locate.

Right temperature in the spray gun almost immediately.



Temperature electronic control



It includes a Heated hose

to get the maximum energy-performance:

- Constant temperature inside the hose, automatically controlled.
- It reduces the minimum working temperature.
- It makes the system independent to the room temperature.
- It reduces the wait time; the working temperature in the spray gun is faster achieved.
- All the advantages from the SAGOLA antistatic hose, now in a heated hose.

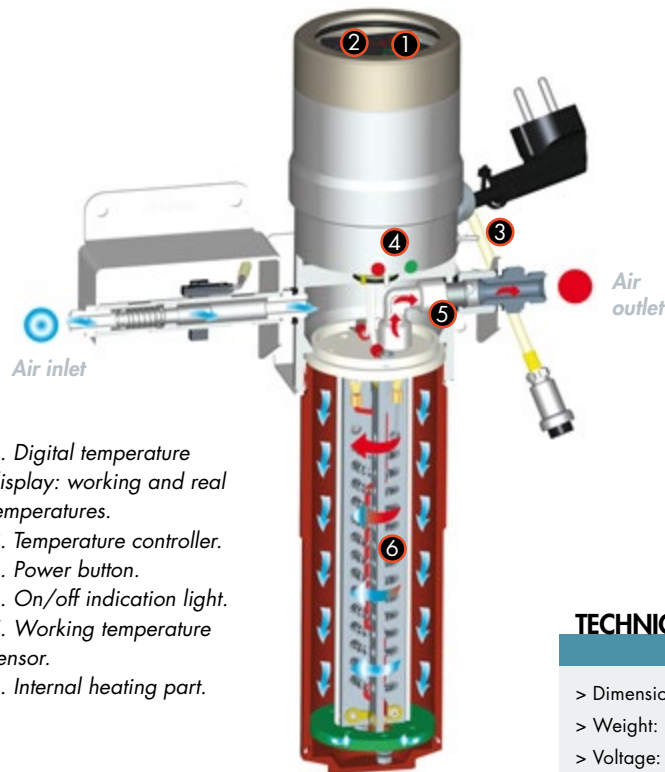

1. Digital temperature display: working and real temperatures.
2. Temperature controller.
3. Power button.
4. On/off indication light.
5. Working temperature sensor.
6. Internal heating part.

Heated hose
11 m. ø10x18 mm.

Code	Version
56414030	220V - 50Hz
Code	Version
56414031	110V - 60Hz

Pack 6000X + Heated hose

Code	Version
10780102	220V - 50Hz
Code	Version
10780104	110V - 60Hz

TECHNICAL DETAILS

- > Dimensions: 455 x 92 x 255 mm
- > Weight: 3.6 Kg
- > Voltage: 240V 50 Hz - 110V 60 Hz
- > Maximum consumption: 800 w
- > Maximum working pressure: 7 bar
- > Maximum flow at 7 bar: 750 L
- Recommended temperatura chart:
- > Clearcoats: 40°C to 60°C
- > Waterborne basecoats: 30°C to 50°C
- > Solvent based basecoats: 30°C to 40°C
- > Termopar temperature sensor.
- > Temperature control device P.I.D.

Air quality test equipment Complements for filtration system

Air quality test equipment

Easy to use

High precision

Code

1502001

Equipment for the detection of air impurities,
 humidity level and temperature.

It incorporates air quality test equipment with
 inlet regulator, flashlight with magnifying glass of
 30 magnification for visualization of impurities,
 humidity meter and digital temperature.

It incorporates membrane filter kit,
 pore 0.45 (50 pcs).



Code	Version
49000740	Membrane filter kit, pore 0.45 (50 units)

COMPLEMENTS for Filters 5000X range

INCREASE THE EFFICIENCY OF YOUR SAGOLA FILTER



Coalescent filter **COUPLING** Turn your 5100X into a 5200X

The definitive solution to problems with solid particles. It incorporates a wide surface coalescent filter. Increase of efficiency up to 0.01 microns. Semi-automatic drain system (+ the automatic drain system of 5100X)

Code

56418521



Active charcoal filter **COUPLING** Turn your 5200X into a 5300X

The best solution to problems of contaminating particles and organic fumes in the air network. It incorporates a wide surface active charcoal cartridge. Semi-automatic drain system (+ 2 drains coming with 5200X)

Code

56418520

Coalescent filter kit (1 unit)

Optimum service life: 6 months



Code	Model
56418071	5200X, 5300X, 5300X+

Active charcoal filter kit (1 unit)

Optimum service life: 3 months



Code	Model
56418070	5300X, 5300X+

Sinterised brass filter kit (1 unit)

Optimum service life: 6 months



Code	Model
56418719	5050X, 5100X, 5200X, 5300X, 5300X+

Timer for filters

The Time Indicators offer a helpful visual reminder of maintenance programs of our filters.

The timer is included in each kit filter.

- 3-month timer
- 6-month timer



Regulating-purifying filter refill

Code	Model
56418720	5000X



Automatic drain system kit

Code	Model
56450010	5050X, 5100X, 5200X, 5300X, 5300X+



Semi-automatic drain system kit

Code	Model
56418533	5000X, 5200X, 5300X, 5300X+



Gasket Kit

Code	Model
56418537	5300X, 5300X+

Pressure gauge

Code	Model
54550016	5000X range

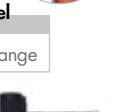

Filter 5000X range display

Code	Model
70000005	5100X
70000006	5200X/5300X



Bodyshop Program II

The widest range of solutions for all kind of professional, from a high demanding bodyshop to a small workshop and including the painting of industrial vehicles.

Always with the maximum production quality, assuring the best durability even in the hardest environments and offering at the same time the most innovative technologies.

Sagola presents a range of spray guns and equipments for the small workshop and the medium industry.

This is a basic but complete line both for professionals and amateur painters.



Finishes **3300 GTO CAR**



Single shaft system

Directly Continuing Xtreme model series with a simplified design, synchronized performance in any kind of situation, minimum spare parts and maintenance reduction.

Highly resistant forged anodized aluminium body

Superlight but robust

Joined steel to steel technology, without sealing gaskets between components

Nozzle + Needle made of stainless steel

Light aircaps made of high-end aluminium mechanized CNC

Wide and comfortable trigger

Maximum spraying

Maximum quality and high performance at bodyshop finish

SAGOLA renews and improves the mid-high range of spray guns for the most demanding bodyshop finishes. Maximum balance between cost and technology. Application of clearcoats, single stages and water-based paints.

Its new forged body and more ergonomic design, coupled with the quality and efficiency of its nozzles (High transfer) make the new **3300 GTO CAR** more attractive and versatile, for maximum brightness and perfect color uniformity in refinish, always with maximum performance.

GTO HVLP aircaps with maximum savings and minimum mist. Transfer 75%.

GTO TECH aircaps with maximum performance regarding time and ease of application. Transfer 65%.

REGULATIONS / PATENTS / REGISTRATIONS

SAGOLA registers the shapes of its guns and its brand/trademark worldwide, and complies with the strictest safety standards and with the strictest standards on solvent emissions:

- > CE
- > EN 1953
- > ATEX II 2G T60°C X
- > SQMDA 1151 CALIFORNIA
- > SQMDA 1136 CALIFORNIA

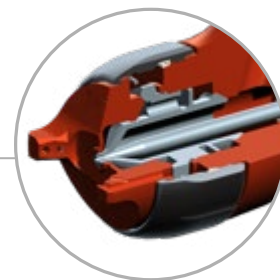

New high-end aluminium aircaps

GTO TECH / GTO HVLP

GTO TECH / GTO HVLP

Ultra-fine droplet size and larger fans.

Designed for the best response to any pressure.

With mechanized aerodynamic lugs which eliminate air turbulence.

It makes top-range paint application easy

Paint saving



TECHNICAL DETAILS

- > Weight without deposit: 423 g
- > Dimensions with cup: 34.5 x 10 x 18 cm
- > Air inlet couplings: 1/4"
- > Cup capacity: 650 ml
- > Cup with removable anti-drip system
- > Design pressure: 8 bar
- > Maximum recommended inlet pressure (working pressure): 2 bar
- > Maximum recommended application distance:
 - 3300 TECH: 18 - 20 cm
 - 3300 HVLP: 12 - 15 cm
- > Maximum paint flow output (1.4 mm. nozzle 20"):
 - 3300 TECH: 179 g/min
 - 3300 HVLP: 161 g/min
- > Air consumption (2 bar inlet):
 - 3300 TECH: 290 L/min
 - 3300 HVLP: 360 L/min
- > Fun size:
 - 3300 TECH [1.8]: 290 - 300 mm.
 - 3300 HVLP [1.8]: 290 - 300 mm.
- > Average sound pressure level: 80 dB
- > Materials in contact with product: chromed aluminium, anodized aluminium, POM, INOX and Teflon.



3300 GTO CAR Finishes

**3300
GTO
CAR**



Single piece automatic paint packing gland

Unique in the market. It avoids manipulation and breakage of the glands and makes easier to remove it for a thorough cleaning of the paint part.

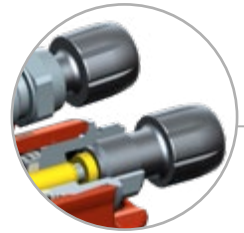

New spray fan regulation design

Modern design without sharp edges, it makes cleaning easier. With connection in stainless steel. With less travel and greater precision. Suitable for right and left-handed operators.



Ergonomic trigger

Made of stainless steel
It reduces fatigue

RC2 Air Flow regulator with gauge

Small and light

It maintains the working pressure according to the parameters of Emissions regulations. (Green scale). **Standard in TECH / HVLP bodyshop versions.**
See page 52



High-precision air flow regulator

Modern design without sharp edges, it makes easier the cleaning process. Better regulation precision. It avoids working loose unwittingly.

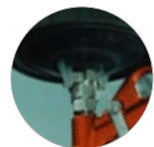

Couplings for disposable deposits PPS

See page 54



Code	Version	Application
10141550	1.20 [TECH]	Clearcoats. Basecoats
10141551	1.30 [TECH]	Clearcoats, basecoats and HS/MS single stage
10141552	1.40 [TECH]	Clearcoats and HS/MS single stage. High speed
10141553	1.20 [HVLP]	Basecoats. Maximum saving
10141554	1.30 [HVLP]	Especially for basecoats and solvents

BODYSHOP
Program II
Fillers and
Primers

Classic Pro XD

Maximum ergonomics and comfort

New body design

No joints between air and paint

Internal air distributor

Nozzles and needles in Stainless steel

Chromed Mate

Classic Pro XD Gravity and Classic Lux Gravity

The best price/quality ratio in conventional primer spray guns.

A new body with improved ergonomics, the widest range of responses and application solutions and complies with the strictest safety standards and with the strictest standards on solvent emissions, distinguish the new model Classic Pro XD.

Single axis system, minimum parts. One single piece automatic paint packing gland. No gaskets.



TECHNICAL DETAILS

- > Weight without deposit: 434 g
- > Dimensions: 34.5 x 10 x 18 cm
- > Air inlet coupling 1/4" male
- > Design pressure: 8 bar
- > Recommended maximum working pressure: 2 bar
- > Recommended distance of application:
HVL: max. 15 cm.
21 EPA & 25/36/28: max. 18 cm.
- > Maximum paint flow output (1.4 mm. 20" nozzle):
Aircap 21: 192 g/min Aircap HVL: 189 g/min
- > Air consumption:
Aircap HVL: 280 L/min Aircap 21 EPA: 240 L/min
Aircap 25/36/28: 320 L/min



Code	Version	Application
10141620	1.40 [21EPA]	High quality finishes. Laquers and Dyes
10141623	1.60 [21EPA]	Primers. HS Primers
10141625	1.80 [21EPA]	HS Primers. High thickness. Fonds, primers
10141627	2.00 [25]	HS Primers. High thickness. Fonds, primers
10141629	2.50 [36]	Fillers. Thick layer. Clearcoats and waterborne paints
10141630	2.80 [28]	Viscous primers
10141621	1.40 [HVL]	Primers
10141624	1.60 [HVL]	HS Primers
10141626	1.80 [HVL]	HS Primers. High thickness. Fonds, primers
10141631	2.50 [HVL]	Fillers. Thick layer

Classic Lux

Gravity version

Robust and economical

Gravity spray gun. Conventional painting system. New chromed body.

Light and versatile with low air consumption.

Air, paint and air flow regulators. Deposit with anti-drip system. Deposit with removable anti-drip system. Incorporates paint filter.

Nozzle and needles in stainless steel.



TECHNICAL DETAILS

- > 0.65 L deposit with anti-drip system
- > Air consumption:
Aircap 40: 215 L/min at 2.0 bar
Aircap 41: 218 L/min at 2.0 bar
Aircap 42: 220 L/min at 2.0 bar
- > Weight without deposit: 538 g

Code	Version	Application
20141406	1.40 [40]	Primers
20141401	1.60 [40]	Fillers and primers
20141402	1.80 [40]	Primers
20141404	2.00 [41]	Primers. High thickness
20141403	2.50 [42]	Primers. High viscosity. Spray gun fillers

**Junior G, 474
 and Venturi Classic**



Junior G

Light and economical gravity spray gun, high transfer and very low air consumption.

Robust, light and with new ergonomic design proper to work with 1.5 HP compressors.

Product and fan regulators.

New body

SAGOLA exclusive design

New aircaps



Code	Version
20141904	1.4 box
20141903	1.6 box
20141902	1.8 box
20141905	1.8 blister

TECHNICAL DETAILS

- > Air consumption: 150 L/min
- > Recommended maximum pressure: 2 bar
- > Weight: 480 g
- > Capacity of deposit: 0.6 L



474

Compact gravity spray gun, due to its small size it is ideal for feathering, small retouches, patches and/or repainting of small parts.

Product, fan and air flow regulators incorporated



TECHNICAL DETAILS

- > Weight with deposit: 325 g
- > Air inlet coupling: 1/4" male
- > Design pressure: 7 bar
- > Deposit: 0.120 L

Code	Version
10151701	0.8
10151702	1.0

Venturi classic

Dryer for
 waterborne paints

Code	Version
40000297	Venturi classic

Code	Version
40000244	Venturi classic Stand + 2 Venturi classic guns



Venturi classic | Drying gun for waterborne products

Venturi classic Stand

Handy and light.
 Multiple adaptability

Totally oriented to
 the typology of the
 part

Code
40000243



Venturi Classic Stand

4000 range filters

4000 SERIES

Maximum painting quality

Ideal for waterborne and HS paints

It holds and automatically drains condensed water and oil

In order to choose the filter system we shall install in our shop, we must take into account the type of air compressor we have, its condition and the quality of the air it is supplying.

In case we are looking for a high quality filtration of particles, water and oil, for painting in a booth

and to get a good finish, the filter 4120 would be suitable for primers, lacquers, clearcoats and enamels.

To get the highest performance and finishing quality with waterborne paints and High Solid (HS) products, we may need even more pure air that contains no particles at all.

In that case we have to install a coalescent filter and regulator, that is, the 4220. With this filter system we will eliminate any solid particle down to 0.01 microns, water aerosols ($C > 0.01 \text{ mg/m}^3$) and oil aerosols ($C > 0.01 \text{ mg/m}^3$).

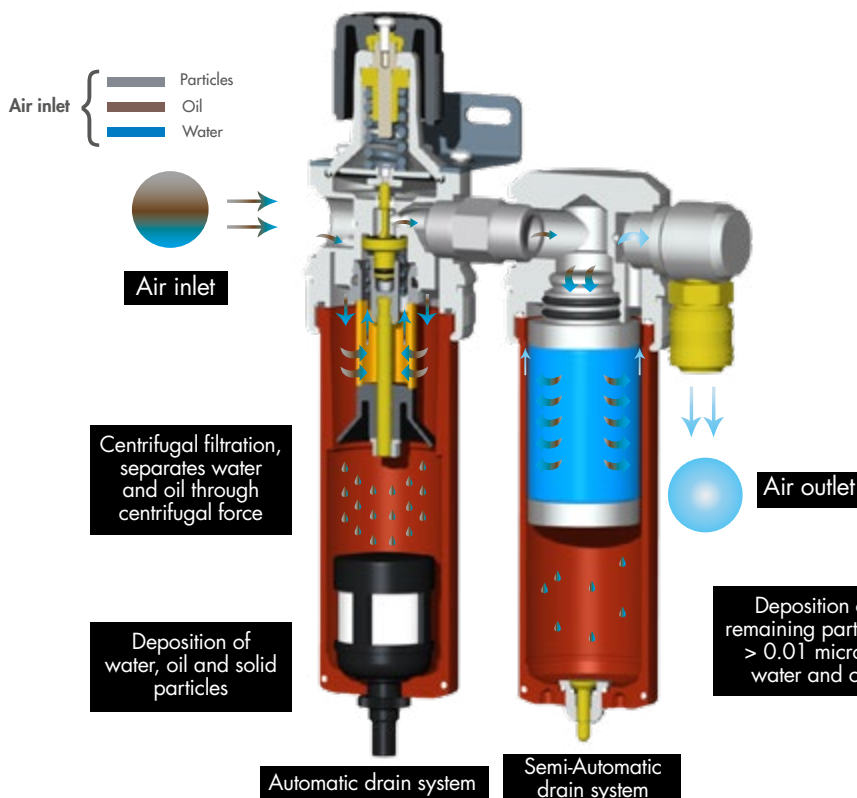

Water/Oil purification degree

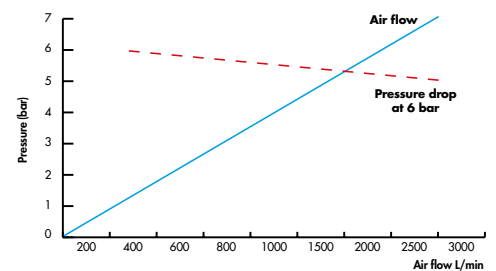
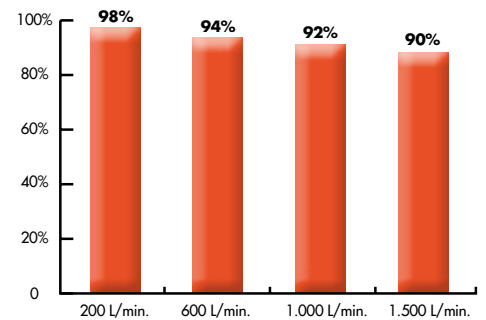

MECHANIZED BODY FROM SOLID ALUMINUM

No diecast parts inside. High strength elements. Longer durability. Oversized air holes, bigger air flow and minimum pressure drops.



ANODIZED TO AVOID RUSTING

Not painted. Anodizing makes it to last longer. Very high resistance to rusting and any other chemical attack.

Highly resistant **ALUMINUM CUP MECHANIZED and ANODIZED** Maximum durability. Minimum maintenance.



OVERSIZED REGULATING WHEEL

Easy-to-use, even with gloves.



HIGH QUALITY AND EASY TO READ MANOMETER

Double scale: bar and psi.

AUTOMATIC DRAINING SYSTEM Automatic purge of condensed liquids without any handling.

EASY-TO-MAINTAIN No tool required for the disassembly. Feeling of robustness. SAGOLA's exclusive design.



4000 range filters

4120

4120 PLUS

Effective solution for compressed air filtration in professional paint booths

Effective solution for compressed air filtration in professional paint booths for: car refinish, wood, machinery, plastics and industry in general.

Highly reliable air regulation system.
Manufactured from a solid aluminum block.
It eliminates air, oil and particles.
Friction and centrifugal filtration.

Automatic drain of condensed liquids.
High air flow. High quality manometer.

4120
(without quick coupling)

Code

10730501

4120 PLUS
(outlet with quick coupling)

Code	Version
10730502	US-Mil
10730503	Nitto
10730504	Euro-profile

TECHNICAL DETAILS

- > Dimensions 4120: 279 x 117 x 69,5 mm.
- > Dimensions 4120 PLUS: 279 x 117 x 96 mm.
- > Weight: 4120: 1,015 gr. 4120 PLUS: 1,220 gr.
- > Brass filter: 20 microns
- > Drain system: automatic
- > Air flow: 1,700 L/min.
- > Maximum pressure: 12 bar
- > Air inlet: 1/2"
- > Coupling 4120 PLUS: US-Mil/Nitto/Euro-profile



4220

4220 PLUS

Recommended for last generation finishes

Two stage air filter. Maximum filtering level.
Recommended for last generation finishes.
Waterborne paints, HS clearcoats and enamels, high gloss lacquers.

Highly reliable air regulation system.
Manufactured from a solid aluminum block.

1st stage: water, oil and particles filtering
+ 2nd stage: submicronic filtering. 0.01 microns

Automatic drain of condensed liquids.
High air flow. High quality manometer.

4220
(without quick coupling)

Código

10750401

4220 PLUS
(outlet with quick coupling)

Code	Version
10750402	US-Mil
10750403	Nitto
10750404	Euro-profile

TECHNICAL DETAILS

- > Dimensions 4220: 279 x 117 x 162 mm.
- > Dimensions 4220 PLUS: 279 x 117 x 186 mm.
- > Weight: 4220: 1,797 gr. 4220 PLUS: 2,002 gr.
- > Brass filter: 20 microns + Coalescent filter: 0.01 microns
- > Drain system: automatic + semi automatic
- > Air flow: 1,700 L/min.
- > Maximum pressure: 12 bar
- > Air inlet: 1/2"
- > Coupling 4220 PLUS: US-Mil/Nitto/Euro-profile



COMPLEMENTS for filters 4000 range



Optional double outlet kit
 Quick couplings SAGOLA US Mil series. Models: 4000 range, 5000 and 5050.

Code
56418704



Automatic drain
 All models

Code
56450010



**Sinterized brass filter
 20 microns**
 All models

Code
56418721



**Coalescent filter
 0.01 microns**
 Models: 4220 and 4220 PLUS

Code
56418722

Vessel Kit + Automatic drain
 4000 range

Code	Version
56417711	4120 PLUS
56417712	4220 PLUS

Semi-automatic drain valve
 4000 range

Code
56417507

Filter 4000 range Display
 4220 Plus Model

Code
70000007



Gasket Kit
 4000 range

Code	Version
56418587	4120 PLUS
56418588	4220 PLUS

Anti-static air hoses
 See "Compressed Air
 Complements" (page 56)



**EASE OF MAINTENANCE
 of 4000 range**

Example of **DISASSEMBLY** of all filtrating elements without the need of key.

**COMPLETE
 DISASSEMBLY**
4220



Quick couplings

New SAGOLA couplings range.
 See page 57 & 58

PLUS
 Range

479
PLUS

The most compact solution for the small workshops, industry or priming and preparation areas

Code	Version
10730401	1/2"
10730402	3/8"
10730403	1/4"

Large air flow, maximum reliability regulating system, high quality pressure gauge, the best materials.

Don't undervalue your small painting works or reduce the life of your pneumatic tools by using poor quality regulators and no filtration capacity. Adaptable to any size of hose. It comes with reducers.

Produced from a solid aluminium block, great filtrating capacity with check window for waste particle and semi-automatic drain system, it has everything in a minimum space.



TECHNICAL DETAILS

- > Dimensions: 229 x 73 x 115 mm
- > Weight: 886 g
- > Brass filter: 40 microns
- > Air flow: 1,700 L/min
- > Couplings: 1/2", 3/8", 1/4"
- > Max. working pressure: 10 bar
- > Draining system: semi-automatic



970
PLUS

Maximum reliability

Assure the supply of clean air and properly lubricated to tools and pneumatic engines

Code	Version
10750301	1/2"
10750302	3/8"
10750303	1/4"

The virtues of the regulator-filter 479 is now united to a lubricating element, setting itself apart as specific workshop equipment. It supplies clean, lubricated air to all your tools.

Accurate control of the oil content by means of a "drop-by-drop" hand regulator, zero pressure loss thanks to the in-line design, maximum reliability and productivity in the most compact package.



TECHNICAL DETAILS

- > Dimensions: 229 x 148 x 115 mm
- > Weight: 1,450 g
- > Brass filter: 40 microns
- > Air flow: 1,700 L/min
- > Connections: 1/2", 3/8", 1/4"
- > Maximum working pressure: 10 bar
- > Draining system: semi-automatic



430 Plus, 439 Plus and 437 Plus filters



430 PLUS

Small, sturdy, reliable
and long lasting

Code	Version
10740501	1/2"
10740502	3/8"
10740503	1/4"

Mini air regulator. Mechanized from a solid aluminium block. Diaphragm regulator from 0 to 10 bar. Quality pressure gauge up to 10 bar. Stand included for assembly on the wall. Standard adaptors and fittings included. Quick release and short shift wheel.

TECHNICAL DETAILS

- > Dimensions: 107 x 65 x 115 mm
- > Weight: 544 g
- > Air flow: 1,200 - 1,700 L/min
- > Couplings: 1/2", 3/8", 1/4"
- > Max. working pressure: 10 bar



439 PLUS

Made of aluminium
High-durability
Maximum robustness

Code	Version
10720401	1/2"
10720402	3/8"
10720403	1/4"

High flow filter for insertion in air lines. Check window for waste liquids. Semi-automatic drain system.

Suitable for all type of installations, accessories included.

TECHNICAL DETAILS

- > Dimensions: 158 x 73 x 73 mm
- > Weight: 553 g
- > Brass filter: 40 microns
- > Air flow: 1,700 L/min
- > Couplings: 1/2", 3/8", 1/4"
- > Max. working pressure: 10 bar
- > Draining system: semi-automatic



437 PLUS

Minimum flow restrictions

Code	Version
10710301	1/2"
10710302	3/8"
10710303	1/4"

Ideal for the proper lubrication of pneumatic tools. Multiple inlet and outlet dimensions (1/2", 3/8" and 1/4"). Manual oil regulator by level check window, drop by drop system. CNC mechanized from a solid aluminium block. Made of aluminium, as the whole Plus range.

TECHNICAL DETAILS

- > Dimensions: 165 x 73 x 73 mm
- > Weight: 482 g
- > Oil filter
- > Air flow: 1,920 L/min
- > Couplings: 1/2", 3/8", 1/4"
- > Max. working pressure: 10 bar



Industrial bodyshop

We transfer all the experience and quality that our trajectory in the industrial sector gives us to the bodywork of large vehicles.

With a thorough selection of our products to give the highest quality finishes to industries dedicated to the painting of industrial vehicles.

Range of spray guns with high quality finishes, high reliability and robustness.

Pumps and pressure pots, ease of use and minimum maintenance to give a great service to professional painting.



DM 1/400 and DM 1/300 complete equipments

DM
1/400

High production

High precision

ATEX  II 2G X

DM 1/400 detail with double product outlet



Code

30920404

TECHNICAL DETAILS

- > Pressure ratio: 1:1
- > Free flow: 40 L/min
- > Product output pressure: 7 bar
- > Air inlet pressure: max.: 7 bar
- > Air consumption: 580 L/min
- > Weight: 18 kg



Double membrane pneumatic equipment.

This is a high production pump. It has been designed and manufactured focusing on the needs of several trades: from small metal, plastic and wood-working factories to the highest level industrial bodyshops.

It can be used with several spray guns at once. Reduced cost and maintenance. Easy-to-use and very low air-consumption.

Lacquers, clearcoats, basecoats, dyes, enamels, primers, fillers, adhesives and medium viscosity products.

Code	Version
30920401	Trolley and absorption
30920402	Trolley and deposit
30920403	Trolley and absorption (abrasives)
30920499	*Full equipment

***Complete equipment (standard), includes DM 1/400 (Trolley and absorption), 4100 Xtreme Pressure 1.20 [XT01 B] and 5 m. air and product hoses.**



DM
1/300

Medium production

High precision

ATEX  II 2G X

TECHNICAL DETAILS

- > Pressure ratio 1 : 1
- > Free flow: 30 L/min
- > Air consumption: 380 L/min
- > Product output pressure: max: 6 bar
- > Air inlet pressure: max. 6 bar
- > Air inlet: 1/4"
- > Product outlet: 3/8"



30L Double membrane Pump.

Medium production. For finish and primers.

High precision product regulator. Anti-pulsation system and double paint filter.

Lacquers, clearcoats, basecoats, enamels. Medium viscosity products.

Code	Version
30920501	Absorption with regulator
30920502	Absorption without regulator
30920503	Deposit with regulator
30920504	Deposit without regulator
30920599	*Full equipment

***Complete equipment (standard), includes DM 1/300 (Trolley and absorption with regulator), 4100 Xtreme Pressure 1.20 [XT01 B] and 5 m. air and product hoses.**





6110 INOX, 610 and 612 pressure pots complete equipments

6110 INOX

Easy handling

Robust

Minimum maintenance

Ideal for Bodyshop and
Marine Industry

Code	Version
10540702	6110 Inox
10540799	*Full equipment

***Complete equipment (standard),**
includes 6110 Inox, 4100 Xtreme
Pressure 1.20 [XT01 B] and 5 m. air
and product hoses.

It offers maximum robustness. Body and lid made of stainless steel.

High precision double regulation and robustness, with discharge valve.

Deposit capacity 10 liters. Top product outlet and manual mixer.

Valid for waterborne and solvent based paints.

TECHNICAL DETAILS

- > Pressure ratio 1 : 1
- > Deposit capacity: 10 L
- > Max. working pressure: 4 bar
- > Air inlet: 1/4"
- > Product outlet: 3/8"
- > ATEX Ex 2 II GX



610

Pressure pot

10 liters capacity

Code	Version
40000273	610
10540798	*Full equipment

***Complete equipment (standard),**
includes 610, 3300 GTO Pressure
1.40 EPA and 5 m. air and
product hoses.

Steel body and aluminium lid.

10 liters deposit capacity. Top outlet and double pressure regulator.

Valid for the medium-low viscosity products application.

TECHNICAL DETAILS

- > Max. working pressure: 4 bar
- > Air inlet: 1/4"
- > Product outlet: 3/8"



612

Ease to use

Minimum maintenance

Ideal for Industrial Bodyshop

Code	Version
10540801	612
10540899	*Full equipment

Air + product
hose kit 1.8 m.

Code

56414128

Pressure pot. Body and lid in aluminum.

Deposit capacity of 2.5 liters. Superior product output and pressure regulator.

Suitable for waterborne and solvent-based paints.

TECHNICAL DETAILS

- > Pressure ratio 1 : 1
- > Deposit capacity: 2.5 L
- > Max. working pressure: 4 bar
- > Air inlet: 1/4"
- > Product outlet: 3/8"



***Complete equipment,** includes 612, 4100 Xtreme
Pressure 1.20 [XT01 B] and 1.8 m. air and product
hoses.

652 INOX and 653 INOX



652
INOX

25 L. tank capacity

Optional interchangeable tank

Made in stainless steel

Double regulation

ATEX 2 II GX
Certificate No. AP - 1035

652 INOX MDS Manual mixer without wheels	Code
	10540320

652 INOX RDC Rotary pneumatic mixer without wheels	Code
	10540321

652 INOX ADC Alternative pneumatic mixer with wheels	Code
	10540322

Pressure pot made in stainless steel with 25 liters tank capacity.

Top product outlet and double pressure regulator.

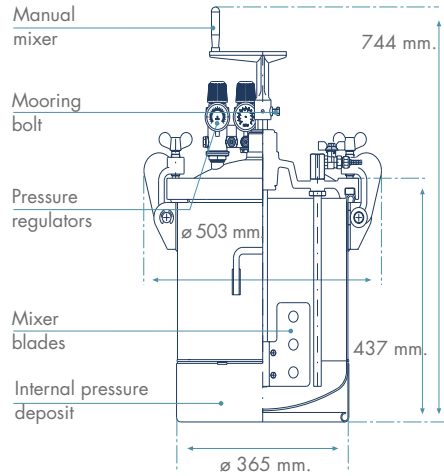

Code	Version
52411608	25 L Stainless steel interchangeable tank



TECHNICAL DETAILS

- > Tank capacity: 25 L
- > Top product outlet
- > With mixer
- > Max. working pressure: 4 bar



653
INOX

50 L. tank capacity

Optional interchangeable tank

Made in stainless steel

Double regulation

ATEX 2 II GX
Certificate No. AP - 1035

653 INOX MDS Manual mixer without wheels	Code
	10540420

653 INOX RDC Rotary pneumatic mixer with wheels	Code
	10540421

653 INOX ADC Alternative pneumatic mixer with wheels	Code
	10540422

Pressure pot made in stainless steel with 50 liters tank capacity.

Top product outlet and double pressure regulator.

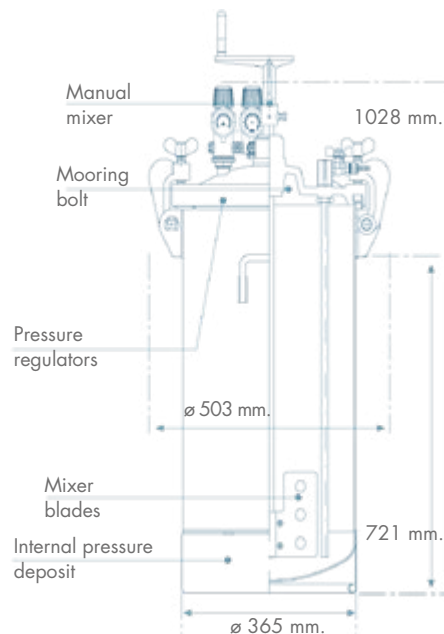

Code	Version
52411609	50 L Stainless steel interchangeable tank



TECHNICAL DETAILS

- > Tank capacity: 50 L
- > Top product outlet
- > With mixer
- > Max. working pressure: 4 bar



4100 XTREME

High flow of paint

Maximum speed, productivity
and ease of application

Time and tiredness saving

Solutions for the new generation
paints, high solids, waterborne
varnish and enamels

Paint saving with top finishes



Wide range of applications with the support of a pressure pot or a low pressure pump. High product transfer. Maximum brightness with the most demanding finishes.

Maximum paint control. Especially recommended color application and metallised. High profitability in continuous painting.

Metals, enamels, clearcoats, primers, dyes, adhesives and texturized.

TECHNICAL DETAILS

- > Weight: 536 g
- > Dimensions: 20 x 18 x 4.2 cm
- > Air inlet coupling BSP 1/4" male
- > Product inlet coupling BSP 3/8" male
- > Design pressure: 8 bar
- > Working pressure: 2.5 - 3.0 bar (Medium Pressure)
- > Working pressure: 2.0 bar (HVLV and EPA)
- > Max. recommended application distance:
20 - 25 cm (Medium Pressure) 15 - 20 cm (HVLV & EPA)
- > Air consumption:
765: 370 L/min XT01 B: 320 L/min
777 : 400 L/min XT03: 530 L/min
20A: 470 L / min 3030: 570 L/min
- > Materials in contact with product:
INOX, chromed aluminium, POM, Teflon and Nylon
- > ATEX 2 II GX



EPA System
65% Transfer
XT01 B / SuperVIT
Special automobile lines

HVLV System
75% Transfer
XT03 / 3030
Max. saving
Min. mist

Medium Pressure
55% Transfer
777 / 765
Max. spraying
Versatility

Code	Version	Application
10152109	1.00 [XT01 B]	Special metalized and clearcoats
10152110	1.20 [XT01 B]	Clearcoats and primers
10152111	1.40 [XT01 B]	Primers and fillers
10152114	1.00 [SuperVIT]	Special metalized and clearcoats
10152115	1.20 [SuperVIT]	Clearcoats and primers
10152107	1.00 [XT03]	High quality finishes. Basecoats, dyes
10152108	1.20 [XT03]	General finishes. Primers
10152113	1.40 [3030]	Minimum mist. Primers, basecoats
10152104	1.00 [777]	Maximum speed
10152105	1.20 [777]	Finishes, high gloss
10152102	1.20 [765]	General finishes. Primers
10152103	1.40 [765]	Primers, basecoats

Extensions

See options in
page 54

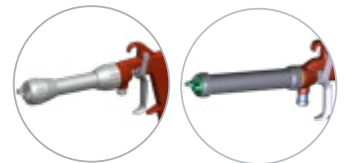

Due to its size it is the perfect spray gun for **restricted access areas** which require a lot of wrist movement. It reduces mist, saves paint and **perfectly defines the work zone**.

TECHNICAL DETAILS

- > Weight: 347 g
- > Air inlet coupling BSP 1/4" male
- > Product inlet coupling: BSP 3/8" male
- > Design working pressure: 8 bar
- > Maximum recommended application distance:
Mini EPA: 15 - 18 cm Mini HVLV: 10 -15 cm
Mini VIT: 18 cm
- > Air consumption:
Mini EPA: 190 L/min Mini HVLV: 335 L/min
Mini VIT: 375 L/min
- > Materials in contact with product:
INOX, Anodized aluminium, POM, Teflon and Nylon
- > ATEX 2 II GX



Mini XTREME

Forged aluminium body,
polishing and anodizing of
high strength

Especially recommended for
dyes and metalics

Ideal for painting chassis
and structures

Highest quality finishes

Perfect ergonomics



Code	Version	Application
10111907	0.80 [miniVIT]	Metalics
10111908	1.00 [miniVIT]	Highest quality finishes
10111909	1.20 [miniVIT]	Finishes. High speed
10111905	1.00 [miniEPA]	Finishes. High quality
10111906	1.20 [miniEPA]	Finishes and primers
10111902	1.00 [mini HVLV]	Metalics, low mist
10111903	1.20 [mini HVLV]	Finishes and primers

BODYSHOP
Industrial Bodyshop
Pressure and suction
spray guns

4100
XTREME

Ideal for painting
industrial vehicles

high capacity deposit (1L) and
high application speed

ATEX  II 2G T60°C X



**4100 Xtreme Suction and
3300 GTO Pressure**



Code	Version	Application
10120601	1.40 [96]	General finishes
10120602	1.60 [96]	
10120603	1.80 [96]	High speed. Finishes and primers
10120604	1.60 [XT01B]	Top quality finishes
10120605	1.80 [XT01B]	High speed. Large surfaces



Lightweight and ergonomic body. Polished and anodized for a high resistance.

Ideal for continuous work sessions. More comfortable painting and less tiredness due to the low gravity center.

Suction system of our 4100 Xtreme allows painting at right angles with the piece when painting bonnets, roofs, vehicles' inside parts, trucks' chassis, trailers, etc.

TECHNICAL DETAILS

- > Weight with deposit: 880 g
- > Dimensions: 30 cm x 18 cm x 11 cm
- > Air inlet couplings 1/4" male
- > Design pressure: 8 bar
- > Maximum recommended inlet pressure (working pressure): 2 - 2.5 bar
- > Air consumption:
 - Aircap 96: 298 L/min
 - Aircap XT01B: 300 L/min
- > Materials in contact with the product: INOX, Chromed aluminium, POM, Teflon, Nylon.



3300
GTO

New forged and
chromed body

High performance and
atomization

New high transfer
aircaps

Light and sturdy

Versatile



Code	Version	Application
10152210	1.00 [HVLV]	Finishes
10152211	1.20 [HVLV]	General finishes
10152212	1.40 [HVLV]	Primers, basecoats
10152214	1.00 [EPA]	Top quality finishes
10152215	1.20 [EPA]	General finishes
10152216	1.40 [EPA]	Primers

Lightweight injected aluminum body. Offering a product of the highest level, with a great ratio quality/price. High performance. High application speed. Large fan size.

Application of enamels, varnishes, primers and basecoats. Nozzles and needles made of stainless steel.

HVLP and EPA aircaps that comply with regulations concerning solvent emissions.

TECHNICAL DETAILS

- > Weight: 478 g
- > Dimensions: 18 x 17.5 x 4 cm
- > Product inlet: BSP 3/8" M
- > Air inlet: BSP 1/4" M
- > Air consumption (2 bar inlet):
 - 3300 EPA: 240 L/min
 - 3300 HVLP: 260 L/min
- > ATEX  II 2G T60°C X



* ASK for special nozzles

Airbrush

In SAGOLA we have always in mind that for achieving success on a project the important point is taking care of little details.

That's why we offer a complete range of airbrushes, kits and complements,

able to satisfy all the needs of:

- > Airbrush design
- > Feathering
- > Parts retouching
- > Parts marking



XTech
100

Ultra-fine nozzle: 0.2 mm.
Maximum precision

Code

17410501



Airbrush nozzle
tip protector
See page 46



Double effect professional airbrush.

0.2 mm. needle and nozzle set up, that offers a superfine spraying, for the highest precision.

Working pressure: 15/30 psi.
Air inlet connection: 1/8" M

0.9 c.c. deposit to use with small quantity of paint.
Ideal for quick color changes.

Needle closing and packing made of Teflon.
Highly precise and smooth air and product valve.

XTech
200

Nozzle: 0.2 & 0.3 mm.
Fine pulverization

Code

Version

17410601

0.2

Code

Version

17410602

0.3



Double effect professional airbrush.

0.2 and 0.3 mm. needle and nozzles, that offer a fine spraying and a high precision.

Working pressure: 15/30 psi.
Air inlet connection: 1/8" M

1.5 c.c. deposit to use with medium amounts of paint. Easy to clean. Ideal for quick color changes.

Needle closing and packing made of Teflon.
Highly precise and smooth air and product valve.

XTech
300

Nozzle: 0.3 mm.
Professional

Code

17410701



Double effect professional airbrush.

0.3 mm. needle and nozzle set up, that offers a fine pulverization and a good precision.

Working pressure: 15/30 psi.
Air inlet connection: 1/8" M

5 c.c. deposit to use any paint quantity, but maintaining the advantage of an easy cleaning and color change.

Needle closing and packing made of Teflon.
Highly precise and smooth air and product valve.

Airbrushes **XTech** series

XTech
400

Nozzle: 0.3 mm.

Good precision



Airbrush nozzle
tip protector
See page 46

Code

17410801



Double effect professional airbrush. Similar to XTech 300 but with a 9 c.c. side tank.

Nedle closing and packing made of Teflon. Highly precise and smooth air and product valve.

0.3 mm. nedle and nozzle set up, that offers a fine pulverization and a good precision. Ideal for murals for a bit thicker colors.

Working pressure: 15/30 psi.
Air inlet connection: 1/8" M

XTech
500

Nozzle: 0.3 & 0.5 mm.

Fine and large spraying

Code Version

17410901 0.3

Code Version

17410902 0.5



Double effect professional airbrush. 0.3 and 0.5 mm. nedle and nozzles, that offer a fine spraying from a high precision to a large spray pattern.

22 c.c. suction deposit with fast change system. Ideal for changing color in an instant.

Recommended for jobs such as shirts and RC. In general, bigger size jobs.

Air inlet connection: 1/8" M

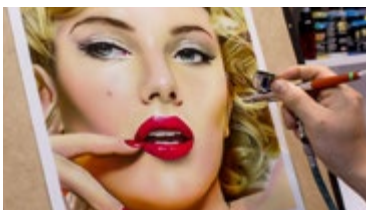



CP1000

Compact

Minimum maintenance

Code	Version
10620701	220V/50Hz
Code	Version
10620702	110V/60Hz



Air compressor for the XTech range airbrushes.
Compact, powerful and reliable.
Minimum maintenance.
Minimum noise level. Ultra silent.
Single cylinder piston compressor.
Includes filter and air outlet regulator.
Automatic stop switch.

TECHNICAL DETAILS

- > Power: 1/6 HP
- > Air flow: 23 L/min.
- > Auto Start at less than 3 bar
- > Auto power off at 4 bar
- > Air outlet: 1/8" M
- > Air tank: 3 L
- > Weight: 5.8 Kg.
- > Dimensions: 310x135x360 mm.
- > Noise level: 47 dB



CP2000

Minimum maintenance

Ultra-silent

Code	Version
10620801	220V/50Hz
Code	Version
10620802	110V/60Hz



Air compressor for the XTech range airbrushes.
Compact, powerful and reliable.
Minimum maintenance.
Minimum noise level. Ultra silent.
Two cylinder piston compressor.
Includes filter and air outlet regulator.
Automatic stop switch.

TECHNICAL DETAILS

- > Power: 1/4 HP
- > Air flow: 35-40 L/min.
- Electric switch:
 - > Auto Start at less than 3 bar
 - > Switch positions:
 - Position 0: Start up
 - Position 1: Auto power at less than 3 bar and automatic stop at 4 bar
 - Position 2: 6 bar of maximum pressure (without automatic stop)
- > Air outlet: 1/8" M
- > Air tank: 3.5 L
- > Weight: 10.7 Kg.
- > Dimensions: 350x140x360 mm.
- > Noise level: 47 dB



Premium 3800



**Premium
3800**

**Complete spray design
equipment kit**

Practical transport case

**High quality retouch and
finishes spray gun**

**Double effect
professional airbrush**

The two star products of SAGOLA range for the professional airbrush with all accessories come together in a practical case.

Equipped with top quality accessories

- **PREMIUM 475** R5/0,5 spray gun with accessories (1 mm. fluid nozzle, aircap, quick connector, fluid needle and accessory tool).
- **XTech 500** airbrush with paint cup, tool, rack and two fully-equipped deposits.
- High quality braided air hose for airbrushes.



Code

25410502



ACCESSORIES Airbrushes

Crystal deposit

22 c.c. with cover and adapter
Code
 40000500

22 c.c. with cover
Code
 40000501

50 c.c. with cover
Code
 40000504

Plastic deposit

60 c.c. with cover and adapter
Code
 40000503

100 c.c. with cover and adapter
Code
 40000502



Code
 52710051

XTech airbrush aircap

New nozzle design for XTech airbrushes, with ultra-fine atomization. It avoids product turbulence. Made of anodized aluminum. Special for paints, colors, ... for fast drying.

Lateral metallic deposits

9 c.c.
 Xtech 400 model
Code
 40000505

7 c.c.
 Xtech 500 model
Code
 52810001



Plug + connector kit

Code
 11011601 M-F BSPP 1/8"

Code
 11011602 F 1/8" at ø4 BSPP (Barb.)

Air hose

Textile - 3 m.
 record 1/8"F-1/8"M
Code
 56414203

Textile - 3 m.
 record 1/4"F-1/8"M
Code
 56414209

Coupling adapter

Coupling adapter braided hose Airbrush of PREMIUM 140.
 F 1/4" and F 1/8" at PREMIUM hose.
Code
 56418032



Airbrush Clean 3N1

Airbrush cleaning recipient.
Code
 40000241



Multi-airbrush rack
 Bench-top airbrush rack.

Code
 40000242



Airbrushes XTech Exhibitor

Code	Name
70000008	Airbrushes XTech Exhibitor

Bodyshop Application Guides, Aircaps, Nozzles and Spray Gun Accessories

Service, a key word in SAGOLA's strategic
approach to bodyshop.

One of our main concerns is to make the painter
be able to quickly identify and acquire the
main SAGOLA original spare parts - nozzles,
needles, aircaps, racks, deposits, regulators...

In this section we offer our application guides
and our main accessories.

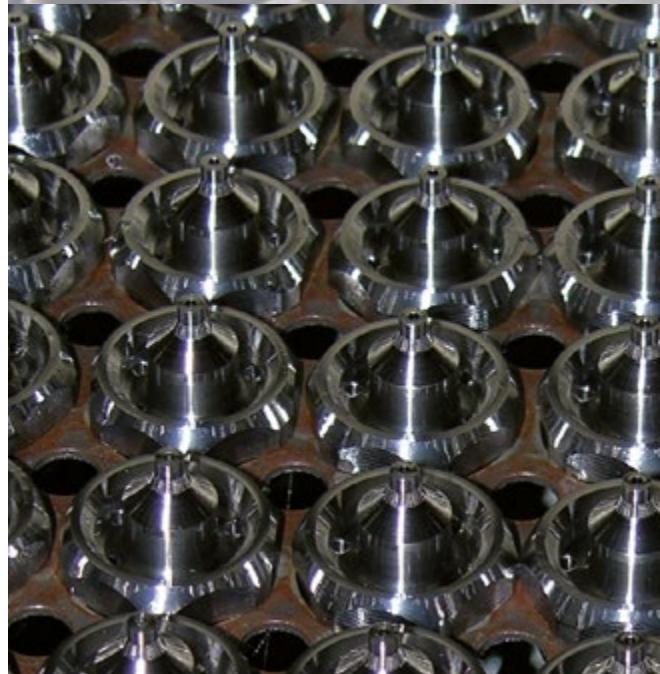



APPLICATION GUIDE

GRAVITY SPRAY GUNS
BODYSHOP

MAXIMUM TECHNOLOGY IN FINISHES

Extreme finishes

Spot Repair

	MODELS	4600 XTREME				MINI XTREME			
		DVR CLEAR	DVR AQUA	DVR HVLP	DVR TITANIA	Mini EPA	Mini AQUA	Mini HVLP	
FINISHES	AIR CAPS								
	Transfer/System	65% EPA	65% EPA	75% HVLP	65% EPA	65% EPA	65% EPA	75% HVLP	
	HS CLEARCOATS	Nozzle + Needle mm.	1.3 - 1.4				1.2		1.2
		Air inlet pressure	2.0 - 2.4				1.8 - 2.0		1.8 - 2.0
	MS CLEARCOATS	Nozzle + Needle mm.	1.3 - 1.3XL				1.0 - 1.2		1.0 - 1.2
		Air inlet pressure	2.0 - 2.4				1.8 - 2.0		1.8 - 2.0
	EXPRESS DRYING CLEARCOATS	Nozzle + Needle mm.	1.2 - 1.2XL			1.2 - 1.2XL	1.0 - 1.2		
		Air inlet pressure	2.0 - 2.4			2.0 - 2.2	1.8 - 2.0		
	WATERBORNE BASECOATS	Nozzle + Needle mm.		1.2 - 1.3	1.2 - 1.3			1.0	1.0
		Air inlet pressure		1.5 - 2.0	1.8 - 2.0			1.0 - 1.5	1.0 - 1.5
SINGLE STAGE	Nozzle + Needle mm.	1.3 - 1.4			1.3 - 1.3XL				
	Air inlet pressure	2.0 - 2.4			2.0 - 2.4				
SOLVENT BASED BASECOATS	Nozzle + Needle mm.		1.2 - 1.3	1.2 - 1.3			1.0	1.0	
	Air inlet pressure		1.5 - 2.0	1.8 - 2.0			1.0 - 1.8	1.0 - 1.8	
FILLERS, PRIMERS	FILLERS Wet/Wet	Nozzle + Needle mm.	1.2 - 1.3XL		1.2 - 1.2XL		1.0	1.0	
		Air inlet pressure	2.0 - 2.2		2.0 - 2.2		1.0 - 2.0	1.8 - 2.0	
	PRIMERS REPAINTING FILLERS	Nozzle + Needle mm.							
		Air inlet pressure							
	HS FILLERS High thickness	Nozzle + Needle mm.							
		Air inlet pressure							
	GUN APPLIED MASTICS	Nozzle + Needle mm.							
		Air inlet pressure							



APPLICATION GUIDE

SUCTION AND PRESSURE
BODYSHOP SPRAY GUNS

Industrial Vehicles

Fast and Robust

	MODELS	4100 Xtreme Pressure				4100 Xtreme Suction	
		XT03 HVLP	XT01 B	765	777	96	XT01
High Gloss Finishes, Clearcoats and Single Stage Paints	AIR CAPS						
	Transfer/System	75% HVLP	65% EPA	55% Conventional	55% Conventional	Medium Pressure	65% EPA
	Nozzle + Needle mm.		1.0 - 1.2	1.2	1.0 - 1.2	1.6	1.6 - 1.8
	Air inlet pressure (bar)		2.0 - 2.5	3.0 - 3.5	3.0 - 3.2	2.8 - 3.0	2.0 - 2.5
Basecoats, Metallized	Paint pressure		0.8 - 1.5	0.8 - 1.5	0.8 - 1.5		
	Nozzle + Needle mm.	0.8 - 1.0	0.8 - 1.0		1.0	1.4 - 1.6	1.6
	Air inlet pressure (bar)	2.0	2.0		2.5 - 3.0	2.5 - 2.8	2.0
Industrial Finishes, Clears, Chassis and Structure Coating	Paint pressure	0.5 - 1.0	0.5 - 1.0		0.5 - 1.0		
	Nozzle + Needle mm.	1.0 - 1.2	1.0 - 1.2	1.2		1.6	1.6 - 1.8
	Air inlet pressure (bar)	2.0	2.0	2.5 - 3.0		2.5 - 3.0	2.0
Fillers and Primers	Paint pressure	1.0 - 1.5	1.0 - 1.5	1.0 - 1.5			
	Nozzle + Needle mm.	1.2 - 1.4	1.2 - 1.4	1.2 - 1.4		1.6	1.6 - 1.8
	Air inlet pressure (bar)	2.0	2.0	2.5 - 3.3		2.5 - 3.0	2.0
	Paint pressure	1.2 - 2.0	1.5 - 2.0	1.5 - 2.0			



COMPETITIVE in finishes Fast and Robust 3300 GTO CAR		FILLERS AND PRIMERS							
		Maximum performance. Profitability 3300 GTO			Light, Robust and Economical CLASSIC PRO XD				
GTO TECH	GTO HVLP	GTO EVO	GTO HVLP	GTO EPA	HVLP	21 EPA	25 50% Conventional	28 50% Conventional	36 50% Conventional
65% EPA	75% HVLP	65% HVLP	75% HVLP	65% HVLP	72% HVLP	65% EPA			
1.4						1.4			
2.0 - 2.5						2.0 - 2.4			
1.3 - 1.4						1.4			
2.0 - 2.2						2.0 - 2.4			
1.2									
2.0 - 2.4									
1.2 - 1.3	1.3 - 1.4					1.4			
1.8 - 2.0	2.0					2.0			
1.3 - 1.4									
2.0 - 2.4									
1.3 - 1.4	1.3 - 1.4					1.4			
1.8 - 2.0	2.0					1.8 - 2.0			
1.3 - 1.4		1,3 - 1,4				1.4			
2.0 - 2.5		2,2 - 2,5				2.8 - 3.0			
			1.6	1.4 - 1.6	1.4 - 1.6	1.4 - 1.6			
			1.8 - 2.0	1.8 - 2.0	2.0	2.5 - 3.0			
			1.6 - 1.8	1.6 - 1.8	1.6 - 1.8	1.8	2.0		
			1.8 - 2.0	1.6 - 2.0	1.8 - 2.0	2.5 - 3.0	2.8 - 3.0		
				2.2 - 2.8				2.5	2.5
				2.0 - 2.5				2.5 - 3.0	2.5 - 3.0





The **aircap model** is vital to achieve the desired results. The type of product we are going to apply and the application system we are going to use must both be taken into account when selecting an aircap. We will obtain the desired spray by correctly combining the aircap with the correct nozzle and needle kit, and a proper air supply.

High transfer aircaps

Code	Aircap	Spray gun	Transfer system	Application	Nozzle + Needle mm.	Air consumption L/min. (2 bar)	Flow g/min.	Max. fan pattern mm.
56418627	DVR TITANIA	4600 XTREME	EPA 65%	EXPRESS DRYING clearcoats Single Stage	1.3 - 1.4	315	208	320
56418630	DVR CLEAR		EPA 65%	HS CLEARCOATS and SINGLE STAGE Highest gloss and performance with extreme atomisation	1.2 - 1.4	295	206	300
56418629	DVR AQUA		EPA 65%	Special WATERBORNE. Ease of application at low pressure	1.2 - 1.4	280	219	300
56418628	DVR HVLP		HVLP 75%	COLOUR Minimum mist, maximum savings and perfect paint uniformity. 0.68 bar at aircap	1.2 - 1.4	450	188	300
56418524	MINI AQUA	MINI XTREME G	EPA 65%	Special SPOT REPAIR, parts coating. Basecoats, clearcoats and waterborne	0.8 - 1.2	190	102	230
56418526	MINI HVLP		HVLP 75%	Special SPOT REPAIR. Basecoats, waterborne and solvent	1.0 - 1.2	325	92	240
56418598	MINI TECH		EPA 65%	Special for low viscosity products	0.6 - 1.0	52	116	50
56418525	MINI EPA		EPA 65%	Basecoats and clearcoats	0.8 - 1.2	190	110	240
56418551	GTO TECH	3300 GTO	EPA 65%	MS y HS CLEARCOATS. Maximum performance and gloss for Good distribution and speed with waterborne COLOUR	1.2 - 1.4	285	170	285
56418552	GTO HVLP		HVLP 75%	Minimum mist, maximum savings and perfect uniformity with basecoats 0.68 bar in aircap	1.2 - 1.4	360	160	275
56418564	XT01 B	4100 Xtreme Presión	EPA 65%	High gloss finishes in pressure	0.8 - 1.4	380	250	300
56418566	XT03		HVLP 75%	Maximum savings and minimum mist. Colour. Water/solvent. 0.68 bar in aircap	1.2 - 1.6	460	180	310
56418647	GTO 62 S	3300 GTO	EPA 65%	Thick fillers	2.8	340	400	280
56418646	GTO 64 S		EPA 65%	Gun-applied mastics	2.2 - 2.5	310	300	290
56418558	GTO EVO		EPA 65%	Fillers Wet/Wet	1.3 - 1.6	255	179	280
56418645	GTO EPA		EPA 65%	Fillers. Minimum air consumption	1.4 - 1.8	335	179	275
56418552	GTO HVLP		HVLP 72%	Fillers. Minimum mist, maximum savings. 0.68 bar in aircap	1.4 - 1.8	365	145	250
56418639	21 EPA	CLASSIC PRO XD	EPA 65%	Finishes, fillers and primers. Maximum performance	1.4 - 1.8	210	192	250
56418643	CLASSIC HVLP		HVLP 72%	Fillers and primers. Minimum mist, maximum savings. 0.68 bar in aircap	1.4 - 1.8	355	189	280

Conventional Aircaps

Code	Aircap	Spray gun	Transfer system	Application	Nozzle + Needle mm.	Air consumption L/min. (2 bar)	Flow g/min.	Max. fan pattern mm.
56418573	96	4100 Xtreme	55%	Clearcoats, single stage, basecoats High speed	1.3 - 1.8	350	220	320
56418571	765	4100 Xtreme Succión	55%	Finishes and primers Wide fan pattern	1.0 - 1.8	410	280	365
56418576	777		55%	Highest spray quality. High gloss finishes. Basecoats.	0.8 - 1.4	420	300	400
56418640	25	CLASSIC PRO XD	50%	Thick fillers	2.0	240	260	300
56418641	28		50%	Primers	2.8	235	-	-
56418642	36		50%	Gun-applied mastics	2.5	240	300	285
56418246	05	475 XTech	50%	Feathering	0.5 - 0.8	100	60	125
56418247	10		50%	Patches, retouching, Parts Coating	1.0	110	90	180
56418271	R5		50%	Rounded spray, maximum precision, retouch and precision marking.	0.5R	45	45	15-100



Nozzle + Needle Kit

Code	Name	Spray gun	Code	Name	Spray gun
10011137	1.20 nozzle+needle kit, 46 series	4600 XTREME	10011198	1.00 nozzle+needle kit	475 XTECH
10011145	1.20 XL nozzle+needle kit, 46 series		10011197	0.80 nozzle+needle kit	
10011138	1.30 nozzle+needle kit, 46 series		10011195	0.50 nozzle+needle kit	
10011139	1.30 XL nozzle+needle kit, 46 series		10011196	0.50 CHR nozzle+needle kit	
10011140	1.40 nozzle+needle kit, 46 series		10011199	2.00 nozzle+needle kit	
10011100	0.80 nozzle+needle kit, 40 series	4100 XTREME 4100 4300 XTREME 4200 450 434	10011380	1.40 nozzle+needle kit + 40 aircap	CLASSIC LUX GRAVITY
10011101	1.00 nozzle+needle kit, 40 series		10011370	1.60 nozzle+needle kit + 40 aircap	
10011102	1.20 nozzle+needle kit, 40 series		10011371	1.80 nozzle+needle kit + 40 aircap	
10011103	1.30 nozzle+needle kit, 40 series		10011372	2.00 nozzle+needle kit + 41 aircap	
10011104	1.40 nozzle+needle kit, 40 series		10011373	2.50 nozzle+needle kit + 42 aircap	
10011106	1.60 nozzle+needle kit, 40 series		10011374	1.60 nozzle+needle kit + 38 aircap	CLASSIC LUX SUCTION
10011107	1.80 nozzle+needle kit, 40 series			10011375	
10011119	2.00 nozzle+needle kit, 40 series		10011376	0.80 nozzle+needle kit	474
10011108	2.20 nozzle+needle kit, 40 series			10011377	
10011109	2.50 nozzle+needle kit, 40 series		4500 XT REME	49000431	1.40 nozzle+needle kit
10011120	2.80 nozzle+needle kit, 40 series	49000432		1.60 nozzle+needle kit	
10011130	1.20 nozzle+needle kit, 45 series	49000433		1.80 nozzle+needle kit	
10011131	1.30 nozzle+needle kit, 45 series	MINI XTREME			
10011134	1.30 XL nozzle+needle kit, 45 series				
10011132	1.40 nozzle+needle kit, 45 series				
10011133	1.60 nozzle+needle kit, 45 series				
10011200	0.80 nozzle+needle kit, Mini series				
10011201	1.00 nozzle+needle kit, Mini series	3300 GTO 4100 GTO 3300 PRO CLASSIC PRO			
10011202	1.20 nozzle+needle kit, Mini series				
10011203	1.30 nozzle+needle kit, Mini series				
10011204	1.40 nozzle+needle kit, Mini series				
10011205	1.60 nozzle+needle kit, Mini series				
10011206	1.80 nozzle+needle kit, Mini series				
10011187	1.00 nozzle+needle kit, 3300 series				
10011180	1.20 nozzle+needle kit, 3300 series				
10011191	1.30 nozzle+needle kit, 3300 series				
10011181	1.40 nozzle+needle kit, 3300 series				
10011182	1.60 nozzle+needle kit, 3300 series				
10011183	1.80 nozzle+needle kit, 3300 series				
10011188	2.00 nozzle+needle kit, 3300 series				
10011192	2.20 nozzle+needle kit, 3300 series				
10011189	2.50 nozzle+needle kit, 3300 series				
10011190	2.80 nozzle+needle kit, 3300 series				
10011254	1.40 nozzle+needle kit	CLASSIC PRO XD			
10011255	1.60 nozzle+needle kit				
10011256	1.80 nozzle+needle kit				
10011257	2.00 nozzle+needle kit				
10011258	2.20 nozzle+needle kit				
10011259	2.50 nozzle+needle kit				
10011260	2.80 nozzle+needle kit				



Air flow regulators



Code
56418020

Flow regulator with pressure gauge RC1

Aluminium, very light. Ideal for high transfer HVLP and EPA spray guns. Red-to-green pressure scale (green within provisions of regulations). Assembled in seconds with hermetic hand tightening.



Code
56418012

High precision flow regulator

High precision air-flow regulator kit. Solvent-proof gaskets. Suitable for 4600 Xtreme digital. Recommended for finishing spray guns.



Code
40000335

Flow regulator RC2

Pressure gauge flow regulator. Exact input pressure gun. High quality gauge green scale for high transfer guns.

Pressurizer kit for gravity spray guns.

Gravity cup pressure kit for high viscosity materials spraying. Non-return valve included.



Code
56418513

Tester 4600 HVLP

Pressure checker for HVLP aircaps (mod. 4600 Xtreme spray gun).

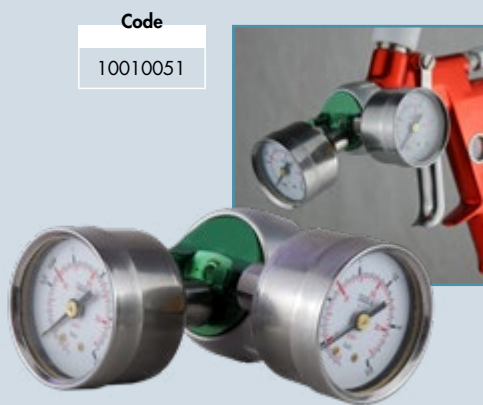

Code
10010051

SP1 model

SP2 model

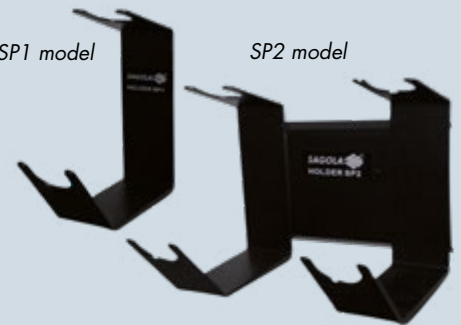

Magnetic Stands SP1 and SP2

Magnetic stand for 1 (SP1) or 2 (SP2) spray guns. Solvent-proof paint. Supports PPS type adapters. Maximum robustness. High holding power due to two powerful magnets.

Accessories for cleaning and maintenance



Cleaning kit

Complete cleaning set, including one brush for outside cleaning, and rods of different sizes for all the inner paths of the spray gun. Supplied in a practical show case.

Code
40000086

Ford 4 viscosimeter

Code
56418001



Code	Model
40000245	SP1
40000246	SP2



Lubricant grease

Natural grease, specially made for spray guns and painting equipments moving parts lubrication. High consistency, even under extreme temperatures. Long lasting, it doesn't lose properties over the time. Easy to open 100 ml. can.

Code
56418589





Demonstration case SAGOLA

Carrying case with capacity for three spray guns and two Sagola gravity deposits. Rigid and resistant. (*Does not include guns and accessories)

Code	Name
10141750	Demonstration case SAGOLA*



Spray Gun Locker

Spray gun and accessories locker. 2 shelves. Ventilation holes for gas removal. Single door locker (2 keys).

Code	Name
70000010	Spray Gun Locker

Gravity deposits

High quality deposit for gravity spray guns.



Code	Name
56418432	0.65 L. Gravity Deposit Kit
56418084	0.65 L. Gravity Deposit Kit
56418085	0.65 L. Gravity Deposit Kit - without filter
56418420	0.65 L. Gravity Deposit Kit
56418080	0.50 L. Gravity Deposit Kit
49000430	0.60 L. Gravity Deposit Kit
56418081	0.125 L. Gravity Deposit Kit
56418079	0.200 L. Gravity Deposit Kit
56418431	0.120 L. Gravity Deposit Kit
56418099	0.125 L. Gravity Deposit Kit
56418505	1 L. Gravity Deposit Kit
56418082	1 L. Metallic Gravity Deposit Kit

Spray guns
4600 Xtreme/4500 Xtreme/4100 GTO
4100 Xtreme/3300 GTO-PRO/Classic PRO XD
4100 Xtreme/3300 GTO-PRO/Classic PRO XD
Classic LUX Gravity
Mini Xtreme Gravity
Junior G
Mini Xtreme Gravity/475 XTECH
Mini Xtreme Gravity/475 XTECH
474
Special Ultra Violet
4600 Xtreme/4500 Xtreme/4100 GTO
4100 Xtreme/3300 GTO-PRO

Product filter kit

Product filter kit for gravity spray guns.

Code	Name
56418017	10 Product Filter Kit (Gravity) 0.65 L
56418438	10 Product Mini-Filter Kit (Gravity)
56418059	10 Product Filter Kit (Gravity) 0.50 L
56418061	6 Product Filter Kit (Gravity) 0.125 L
56418479	5 Product Filter Kit (Gravity)

Spray guns
4100 Xtreme/3300 GTO-PRO/Classic PRO XD
4600 Xtreme/4500 Xtreme/4100 GTO
Mini Xtreme Gravity
Mini Xtreme Gravity
474

Extensions



Extensions for 4100 Xtreme

Version extension for 4100 Xtreme spray gun. 150, 300 and 500 mm. extensions for a variety of needles.

Code	Name
52411721	Extension 150 mm. 1.00 4100 Series
52411722	Extension 150 mm. 1.20 4100 Series
52411723	Extension 150 mm. 1.40 4100 Series
52411724	Extension 300 mm. 1.00 4100 Series
52411725	Extension 300 mm. 1.20 4100 Series
52411726	Extension 300 mm. 1.40 4100 Series
52411727	Extension 500 mm. 1.20 4100 Series
52411732	Extension 500 mm. 1.80 4100 Series



Extensions for MiniXtreme

Version extension for Mini Xtreme spray gun. 150 and 300 mm. extensions for a variety of needles.

Code	Name
52411713	Extension 150 mm. 0.80 MiniXtreme
52411714	Extension 150 mm. 1.00 MiniXtreme
52411715	Extension 150 mm. 1.20 MiniXtreme
52411716	Extension 150 mm. 1.40 MiniXtreme
52411717	Extension 300 mm. 0.80 MiniXtreme
52411718	Extension 300 mm. 1.00 MiniXtreme
52411719	Extension 300 mm. 1.20 MiniXtreme
52411720	Extension 300 mm. 1.40 MiniXtreme

Couplings

for disposable deposits

Code	Name	Spray Gun
55711607	Coupling for disposable deposits 3M PPS	4600 XTREME/4500 XTREME/4100 GTO
55711617	Coupling MIPA / CARWOX	4600 XTREME/4500 XTREME/4100 GTO
55711609	Coupling GERSON / NORTON	4600 XTREME/4500 XTREME/4100 GTO
55711610	Couplings FLEXI CUP	4600 XTREME/4500 XTREME/4100 GTO
55711619	Coupling Devilbiss / DEKUPS	4600 XTREME/4500 XTREME/4100 GTO
55711621	Coupling SATA RPS	4600 XTREME/4500 XTREME/4100 GTO
55711624	Coupling COLAD	4600 XTREME/4500 XTREME/4100 GTO
55711612	Coupling for disposable deposits 3M PPS	4100/3300 GTO/3300 PRO/Mini XTREME
55711616	Coupling MIPA / CARWOX	4100/3300 GTO/3300 PRO/Mini XTREME
55711614	Coupling GERSON / NORTON	4100/3300 GTO/3300 PRO/Mini XTREME
55711615	Coupling FLEXI CUP	4100/3300 GTO/3300 PRO/Mini XTREME
55711618	Coupling Devilbiss / DEKUPS	4100/3300 GTO/3300 PRO/Mini XTREME
55711620	Coupling SATA RPS	4100/3300 GTO/3300 PRO/Mini XTREME
55711623	Coupling COLAD	4100/3300 GTO/3300 PRO/Mini XTREME



Suction Deposit Gaskets and Filters

Code	Name	Spray Gun Range
56418074	Suction Deposit Kit 1.00 L	4100 Xtreme/Classic PRO XD/Classic LUX
56418076	Suction Deposit Kit 0.5 L. (403/435)	403/435
56418014	10 Product Filter Kit (Suction)	4100 Xtreme/Classic PRO XD/Classic LUX
56418013	5 Suction Spray Gun Anti-drip Lid Kit	4100 Xtreme/Classic PRO XD/Classic LUX
56418509	Deposit Closure Flanged Washer	4100 Xtreme/Classic PRO XD/Classic LUX



Other kits and accessories

Air valves, paint packing, joints,...

Code	Name	Spray Gun Range
56418445	Air Valve Kit	XTREME Range
56418514	Air Valve Kit	Mini XTREME
56418481	Air Valve Kit	4100 GTO/3300 GTO-PRO/Classic PRO/Classic LUX
56411616	Paint Packing Nut	4600 Xtreme/4500 Xtreme/4300/4100
56418034	Paint Packing Nut. Needle + Product	Mini Xtreme
56418441	Air Gasket Replacement Kit (6 units)	4600 Xtreme/4500 Xtreme/Mini Xtreme
56418494	Air Gasket Replacement Kit (6 units)	4100 GTO/3300 GTO-PRO/Classic PRO/Classic LUX
49000422	Air Valve Kit	Junior G
49000425	Paint Packing Nut	Junior G
56418449	Air Valve Kit	474
56418452	Paint Packing Nut	474
56418703	Close Gasket Replacement Kit	518 PRO

Compressed air
complements
Connection accessories
General application
spray guns

Anti-static hoses, connectors, quick couplings, couplings and seals are elements which complement a good tool with safe, quality work for the painter and panel beater.

The weakest link breaks the chain, we are aware of that here in SAGOLA, and no concessions are made in our accessories range. A safe bet for your professional needs.



Hoses **Air and product hoses**



Anti-static compressed air hose

Ideal for painting in the booth

Light, flexible and manageable

Twist free



Anti-static EPDM rubber hose with exterior textile reinforcement. Ideal for painting in the booth.

High security crimped ends able to bear the high temperatures of the booth. No need to use flanges, avoiding that they release or cause leaks due to dilation.

TECHNICAL DETAILS

- > Working temperature: -40°C to +120°C.
- > Working pressure: 20 bar
- > Breaking strain 80 bar
- > Anti-stick exterior
- > Internal diameter 8 mm. Valid for to be used with HVLP high flow guns
- > Meets Regulation 97/23/CE
- > 1/4" H couplings with conical closure and flare fitting for easy assembly of the push connector
- > Conducting pipe < 1 M Ω
- > Max. temperature: 120°C
- > Tough (breaking strain 80 bar)

Code	Version
56414014	2.5 m. 6 x 12 mm.
56414024	6 m. 8 x 15 mm.
56414025	11 m. 8 x 15 mm.
56414027	16 m. 8 x 15 mm.
56414026	26 m. 8 x 15 mm.

Air and product hose + cover

Light and flexible

For low pressure equipments

Nylon protective cover



Nylon product hose 6x8 mm. with quick connect terminals. Adapter 3/8" female for pressure sprayguns.

EPDM rubber anti-static air hose 8x15 mm. with high security crimped ends 1/4" F.

Nylon protective cover of high resistance to friction and abrasion.

TECHNICAL DETAILS

Product hose:

- > Working temperature: -20°C to +60°C
- > Working pressure: 18 bar
- > Material: Polyamide
- > 6 mm. inner diameter
- > 8 mm. outer diameter
- > Connection: Racord 3/8"
- > Approval DIN 73378

Air hose:

- > See Anti-static compressed air hose.

Cover:

- > Working temperature: -60°C to +125°C
- > Material: Poliester
- > 40 mm. outer diameter

Code	Version
56414039	5 m.
56414044	7,5 m.
56414040	10 m.
56414041	15 m.
56414042	20 m.

100 m roll of hose

Multi-use hose

Meets Regulation 97/23/CE



Compact with excellent performance and oil resistance.

TECHNICAL DETAILS

- > 8 x 15 mm. air hose in 100 metre rolls
- > Thermal cork hose with exterior polyester reinforcement
- > Working pressure: 20 bar
- > Breaking strain 60 bar
- > Working temperature: -15°C to +60°C

Code
52450008

Quick couplings and connectors

FEATURES
NEW RANGE
Couplings and connectors



Max. pressure: 25 bar
Europerfil max. pressure: 15 bar
Aluminum plugs max. pressure: 20 bar

The new range of plugs SAGOLA presents cutting-edge design. SAGOLA offers a wide range that gives cover 100% of market requirements. Is incorporated security versions. All steel and aluminum plugs are BSP; Males (BSPT) and females (BSPP).

Plug body made of treated steel and valve made of brass. So a guaranteed life of more than 1,500,000 uses. The new range of plugs SAGOLA incorporates a handle made of composite, which gives a high resistance to both attrition and drag. Attrition resistance tested in more than 48,000 impacts and the equivalent to a crawl 12 km.



The quick couplings are supplied in individual blister packs

1. SHOOTER made of composite with a weight reduction and extraordinary durability against impact (48,000 impacts test).

2. BODY PLUG made of steel with anticorrosive treatment.

3. VALVES Brass valve manufactured, specific to work at high temperatures.

4. JOINTS Nitrile Butadiene. Operating temperature range: -20°C +100°C.

5. PINS made of tempered high strength steel that guarantees the absence of attrition.

6. SPRING made of stainless steel.

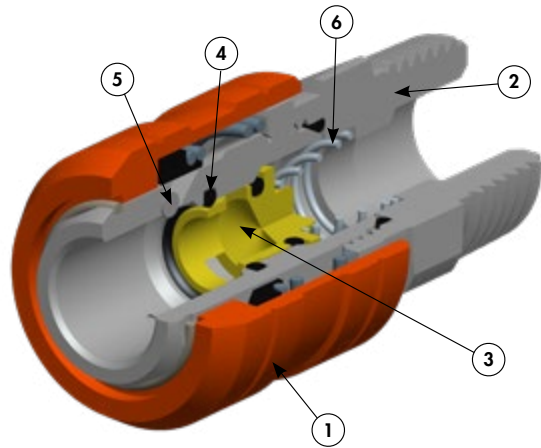

Ultra-Light range. Ultra-light weight. 45 g.

US-Mil range

ULTRA LIGHT

US-Mil RANGE

Flow: 68 m³/h. - 1,133 L/min.
Body and shooter made of high strength aluminum. Valve made of brass. Pins made of high strength steel.
Air coupling: 1/4"



Code	Version
11010531	BSPT 1/4"



Code	Version
11010431	BSP 1/4"



Code	Version
11010629	Barb. 8 mm.

US-Mil range

Air coupling: 1/4" Flow: 68 m³/h. - 1,133 L/min.

US-Mil RANGE

Simple shutter plug, made of hardened steel with gasket made of Nitrile Butadiene. Its excellent sealing prevent dirt penetrates inside. High strength sleeve.



Code	Version
11010524	BSP 1/4"
11010525	BSP 3/8"
11010526	BSP 1/2"



Code	Version
11010424	BSP 1/4"
11010425	BSP 3/8"
11010426	BSP 1/2"



Code	Version
11010624	Espiga 8 mm.
11010625	Espiga 10 mm.

Code	Version
11010527	BSP 1/4"
25 units	

Code	Version
11010427	BSP 1/4"
25 units	

Code	Version
11010626	Barb. 8 mm.
25 units	

US-Mil range

SAFETY Plug

Air coupling: 1/4" Flow: 68 m³/h. - 1,133 L/min.

US-Mil RANGE

Plug with gasket made of Nitrile Butadiene and double effect opening. Anti-whiplash safety plug according to ISO-4414. Two movements "push-pull" to disconnect.
High strength sleeve.



Code	Version
11010528	BSPT 1/4"
11010529	BSPT 3/8"
11010530	BSPT 1/2"



Code	Version
11010428	BSP 1/4"
11010429	BSP 3/8"
11010430	BSP 1/2"



Code	Version
11010627	Barb. 8 mm.
11010628	Barb. 10 mm.

Quick couplings



Euro-Profile range

Air coupling: 7.6 mm. Flow: 85 m³/h. - 2,000 L/min.

Quick coupling

Euro Profile RANGE

Simple shutter plug, made of hardened steel with gasket made of Nitrile Butadiene. Its excellent sealing prevent dirt penetrates inside.



Code	Version
11010823	BSPT 1/4"
11010824	BSPT 3/8"
11010825	BSPT 1/2"



Code	Version
11010723	BSPP 1/4"
11010724	BSPP 3/8"
11010725	BSPP 1/2"



Code	Version
11010924	Barb. 8 mm.
11010923	Barb. 10 mm.

Euro-Profile range

SAFETY Plug

Air coupling: 7.6 mm. Flow: 85 m³/h. - 2,000 L/min.

Quick coupling

Euro Profile RANGE

Plug with gasket made of Nitrile Butadiene and double effect opening. Anti-whiplash safety plug according to ISO-4414. Two movements "push-pull" to disconnect. High strength sleeve.



Code	Version
11011323	BSPT 1/4"
11011324	BSPT 3/8"
11011325	BSPT 1/2"



Code	Version
11011423	BSPP 1/4"
11011424	BSPP 3/8"
11011425	BSPP 1/2"



Code	Version
11011523	Barb. 8 mm.
11011524	Barb. 10 mm.

Multi-Profile range

3x1 system. Compatibility: US-MIL/EUROPROFILE/ITALIANO PROFILE

Quick coupling

Multi-Profile RANGE

Flow: 85 m³/h. - 2,000 L/min. Simple shutter plug, made of steel with gasket made of Nitrile Butadiene. Its excellent sealing prevent dirt penetrates inside. Air coupling: 8 mm.



Code	Versión
11010826	BSPT 1/4"
11010827	BSPT 3/8"



Code	Versión
11010726	BSPP 1/4"
11010727	BSPP 3/8"



Code	Versión
11010925	Barb. 8 mm.
11010926	Barb. 10 mm.

Nitto range

ASIA-PACIFIC MARKET EXCLUSIVE PROFILE

Quick coupling

Nitto RANGE

Flow: 85 m³/h. - 2,000 L/min. Simple shutter plug, made of steel with gasket made of Nitrile Butadiene. Its excellent sealing prevent dirt penetrates inside. Air coupling: 8 mm.



Code	Versión
11011701	BSPT 1/4"
11011702	BSPT 3/8"



Code	Versión
11011801	BSPP 1/4"
11011802	BSPP 3/8"



Code	Versión
11011901	Barb. 8 mm.
11011902	Barb. 10 mm.

US-Mil range

BRASS Plug

Quick coupling

US-Mil RANGE-Spec C-4109

600 L/min Versatile. Simple blocking plug made of brass with Buna N gasket. Its excellent sealing avoids the penetration of impurities to the inside. Fully compatible with earlier lines of SAGOLA plugs.



Code	Version
11010520	BSPP 1/4"
11010521	BSPP 3/8"
11010522	BSPP 1/2"



Code	Version
11010420	BSPP 1/4"
11010421	BSPP 3/8"
11010422	BSPP 1/2"



Code	Version
11010621	Barb. 8 mm.
11010622	Barb. 10 mm.

Code	Version
11010523	BSPP 1/4"
25 units	

Code	Version
11010423	BSPP 1/4"
25 units	

Code	Version
11010623	Barb. 8 mm.
25 units	

Quick Couplings, Threaded Couplings

FEATURES Couplings and connectors SIZE 2

The size 2 plug is the most commonly used push plug in paint and body shops, and also in industry for the connection of all kinds of pneumatic tools. Silicone free.
All springs, valves and pins made of stainless steel. All SAGOLA connectors are manufactured in high carbon steel making them extremely strong and stress resistant.

US-Mil range

Connector without blocker, made of steel.

Quick coupling

US-Mil-Spec C-4109 RANGE
(2 units) ID 5.5 mm.
Fully compatible with earlier lines of SAGOLA plugs. Made of high-carbon steel. Anti-corrosive nickel etched finish. Connector without blocker.



Code	Version
11020420	BSPT 1/4"
11020421	BSPT 3/8"
11020422	BSPT 1/2"
Code	Version
11020423	BSPT 1/4"
	50 units



Code	Version
11020520	BSPP 1/4"
11020521	BSPP 3/8"
11020522	BSPP 1/2"
Code	Version
11020524	BSPP 1/4"
	50 units



Code	Version
11020621	Barb. 8 mm.
11020622	Barb. 10 mm.
Code	Version
11020623	Barb. 8 mm.
	50 units

Orientable quick coupling
with exclusive rotating dial system, for greater freedom of movement.



Code	Version
11020523	BSPP 1/4"



Euro-Profile range

Maximum performance and durability in high production workshops.

Quick coupling

Euro Profile RANGE (2 units)
High flow. ID 7-8 mm.
Made of high-carbon steel. Anti-corrosion blue galvanized finish. Connector without blocker.



Code	Version
11020710	BSPT 1/4"
11020721	BSPT 3/8"
11020722	BSPT 1/2"



Code	Version
11020810	BSPP 1/4"
11020821	BSPP 3/8"
11020822	BSPP 1/2"



Code	Version
11020921	Barb. 8 mm.
11020922	Barb. 10 mm.

Nitto range

ASIA-PACIFIC MARKET EXCLUSIVE PROFILE

Quick coupling

Nitto RANGE (2 units)
High flow. ID 7-8 mm.
Made of high-carbon steel. Anti-corrosion blue galvanized finish. Connector without blocker.



Code	Version
11021001	BSPT 1/4"
11021002	BSPT 3/8"



Code	Version
11021101	BSPP 1/4"
11021102	BSPP 3/8"



Code	Version
11021201	Barb. 8 mm.
11021202	Barb. 10 mm.

Threaded couplings

Connection coupling

(2 units)
High flow.
Made in brass. Anticorrosive treatment.

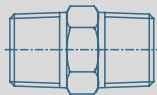

Code	Version
11000101	BSPT 1/4" M - M
11000102	BSPT 1/2" M - M
11000103	BSPT 3/8" M - M



Code	Version
11000106	BSPP 1/2" F at 3/8" M
11000107	BSPP 3/8" F at 1/4" M
11000108	BSPP 3/8" M at 1/4" F

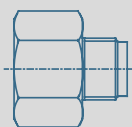

Code	Version
11000104	BSPT 1/2" M at 3/8" M
11000105	BSPT 3/8" M at 1/4" M
11000112	BSPT 1/2" M at 3/8" F
11000113	BSPT 1/2" M at 1/4" F

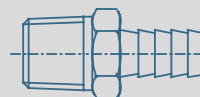

Code	Version
11000109	BSPT 1/2" M at 8 mm. barb.
11000110	BSPT 3/8" M at 8 mm. barb.
11000111	BSPT 1/4" M at 8 mm. barb.

3900 Plus sealers



3900 PLUS

Sturdy aluminum body

Quick Closing

Metal air distributor

Discharge valve

1/4" Standard Connection

Code	Version
10330201	3900 Plus
10330401	3900 Plus M4
10330402	3900 Plus M6

The new 3900 Plus pneumatic sealers are a compact, efficient and light solution for everyday needs in any workshop. These pneumatic guns are very useful when it comes to structure assembling, repairs and windshield set-ups, among others.

There are two versions: the 3900 Plus for sealants in cartridges and the 3900 Plus M for sealants in sausages. Both versions include a trigger with discharge valve, which guarantees a great precision and control.

The metallic internal parts assure a long working life. Besides, those parts do not require any manipulation neither any maintenance.

Its body is made of high resistance aluminum. The front part on the 3900 Plus is made of non-deformable plastic.

The 3900 Plus sealers are a very strong product capable to work for long working hours.

TECHNICAL DETAILS 3900 PLUS - CARTRIDGE

- > Front part made in plastic.
- > Bead application of sealers and silicone in 300 ml.
- > Weight: 540 g / Length: 250 mm
- > 1/4" Air inlet
- > Discharge valve to shut-off the product outlet when releasing the trigger.
- > Working pressure: 4 - 6 bar

TECHNICAL DETAILS 3900 PLUS M - SAUSAGE

- > Front part made in anodized aluminum.
- > Bead application of sealers and silicone in sausage:
300 & 400 ml. **3900 PLUS M4**
600 ml. **3900 PLUS M6**
- > **3900 PLUS M4:** Weight: 560 g / Length: 250 mm
3900 PLUS M6: Weight: 570 g / Length: 320 mm
- > 1/4" Air inlet
- > Discharge valve to shut-off the product outlet when releasing the trigger.
- > Working pressure: 4 - 6 bar



Pneumatic undercoating gun 518 Pro and 416

518 PRO

Flow and spray size regulation

Operating pressure

Code

10330301



Pressurized pneumatic gun for antigravel cartridges and underbody protection.

Total regulation on product flow and quality of atomization and spray size. Air inflow regulator.

Operating pressure. The cartridge container is made in anodized aluminum. It is light and sturdy. Needle regulator to control precisely the texturing. Very accurate depressurizing valve. It is easy to handle even with gloves.

Special air cap for cavity wax, that includes two types of dispensers. (OPTIONAL). Stainless steel silencer.

The 518 Pro works with low pressure and offers the maximum regulation options and productivity.



TECHNICAL DETAILS

- > Empty weight: 1,369 g
- > Connection: 1/4" male coupling
- > Air consumption: 160 L/min at 3.5 bar air pressure
- > Working pressure: 2 bar - 4 bar
- > Maximum pressure: 10 bar



Nozzle Kit + Spray gun adapter

Code

56418705

Special nozzle (Optional)



416

Screwed directly to the cartridge

Operation by suction

Adjustable metallic aircap

Code

20330401

Pneumatic gun for antigravel cartridges and underbody protection. Operation by suction.

Gun for the application of standardized acoustic insulation 1 L. cartridges. To be screwed directly to the cartridge.

Adjustable metallic aircap to control the quantity and texture of the product.

TECHNICAL DETAILS

- > Empty weight: 520 g
- > Connection: 1/4" male coupling
- > Air consumption: 160 L/min at 3.5 bar air pressure
- > Working pressure: 3 bar - 10 bar



Classic S1 blowguns, Pocket blower and inflating-gun Classic I Plus

Classic S1

Blowgun

Made of aluminum

Light and robust

Code	Version
20340601	Metallic aircap
20340604	With extension
20340603	Plastic aircap

Three versions of the blow gun Classic S1:

- Classic S1 with metallic aircap.
- Classic S1 with extension.
- Classic S1 with plastic aircap.

Blowgun with body built in aluminum. Light but robust.

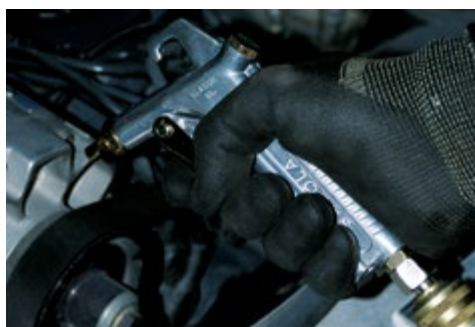

Classic S1
Metallic aircap

Classic S1
Plastic aircap

Classic S1
With extension

Classic S1 Venturi

Sistema venturi

Alto caudal de aire

Code
20340605

TECHNICAL DETAILS

- > 1/4" male coupling
 - > Air consumption: 240 L/min. at 6 (air inlet pressure)
 - > Working pressure: 3 bar - 10 bar
 - > Maximum pressure: 10 bar
 - > Classic S1 plastic weight: 187 g.
 - > Classic S1 metallic weight: 190 g.
 - > Classic S1 extension weight: 198 g.
 - > Classic S1 Venturi weight: 225 g.
- Classic S1 Venturi**
- > Air outlet: 925 L/min. at 6 bar



Classic S1
Venturi system

Pocket blower

Code
40000336

Pocket clip. Adjustable flow.
Quick disconnect connector.



Classic I Plus

Code
10310201

Professional inflating gun - pressure checker.

Manufactured in aluminum. Maximum robustness and reliability.

TECHNICAL DETAILS

- > Hose length: 0.5 m
- > Working pressure: 0 - 10 bar
- > Shock-protected pressure gauge
- > Weight: 800 g



Complements and accessories for the workshop

Washers

A clean spray gun is a fundamental step to achieve higher quality work and longer useful tool life with the minimum maintenance.

But in workshop, adequate management and handling of solvents and cleaning products is also vital.

For the above reasons we at SAGOLA work hard to offer a professional range of spray gun cleaners.

Infra-reds

Workshop productivity directly affects profitability, and both are directly conditioned by drying times.

Crushers

Why increase waste disposal costs of paint cans, paper and cardboard because you can not reduce their volume?

Personal Protection

Protective masks for sanding and painting processes, anti-static painters' overalls... One of SAGOLA's main concerns is to assure optimum, safe working conditions for all.

Sanding Systems

Day-to-day tasks in the workshop: pre-paint sanding, masking, booth maintenance... common operations which, however, are vital to achieve the desired result.

At SAGOLA we are pleased to contribute with our experience and services to help you achieve this aim.



Compact 220 and S 25



Automatic wash with reused/clean solvent
Pump absorption filter
Minimum maintenance
Robust and easy to use



This version incorporates:
 Interior fumes outlet.
 Stainless steel grid conduits.
 Safety valve.



Pneumatic blowing device
 to avoid the penetration of solvent into the interior of the gun.

Code

40000199

COMPACT220

Compact machine of small size, ideal for small paint shops.

Designed to automatically clean spray guns when working with solvent-based paints and clearcoats.

Equipped with dual automatic cleaning system, with reused and clean solvents; and two working modes; manual flush air nozzle to avoid the solvent entering the air inlet or automatic.

Pneumatic blowing device to avoid the penetration of solvent into the interior of the gun.

TECHNICAL DETAILS

- > 1,000 x 480 x 550 mm
- > Weight: 50 kg
- > Sustainable load: 20 Kg
- > Capacity of the washing unit: 38 L
- > Working pressure: max. 10 bar
- > Compact, occupies minimum space
- > Automatic wash with reused/ clean solvent
- > Timer
- > Automatic extraction of fumes
- > Made of stainless steel
- > CE certification
- > ATEX  II 3GD

S25

Compact, small size
Automatic highly efficient built-in extraction

Capacity for 2 guns, 2 cups and lids

100% Stainless Steel

Compact machine of small size, ideal for small paint shops. Designed to automatically clean spray guns and painting accessories when working with solvent-based paints and clearcoats.

Equipped with pump absorption filter and timer for 15 minutes. Easy to use. Maximum robustness. Minimum maintenance.

TECHNICAL DETAILS

- > 550 x 500 x 980 mm
- > Weight: 25 Kg
- > Capacity: 2 guns, 2 cups
- > Working max. pressure: 6 bar
- > Compact and small size
- > Pump absorption filter
- > ATEX  II 3GD



Code

40000521

Compact 235 and Aqua Plastic +

Auto-extraction
of solvent vapors

Atomizer venturi

Blowgun for drying
the gun interior areas

Brush for washing the
gun exterior areas

Code

40000522

COMPACT 235

Designed to clean automatically spray guns and painting accessories when working with solvent-based paints and clearcoats.

Recirculation solvent automatic cycle (timer). Automatic final cycle of clean solvent. Equipped with dual automatic cleaning system, with reused and clean solvents, this latter can be dosed in a timed or manual.

Pneumatic blowing device to avoid the penetration of solvent into the interior of the gun. 100% Stainless Steel.

TECHNICAL DETAILS

- > 1,520 x 700 x 530 mm
- > Weight: 50 Kg
- > Sustainable load 20 kg
- > Washing area volume: 38 Litres
- > Working pressure: 10 bar
- > CE certification
- > ATEX  II 3G



Brush with water for cleaning
the exterior of the gun

Gun with coupling to clean
interior areas

Blowgun for drying

Filter mat for residues and
pump absorption filter

Code

40000177



Filter mat for
residues and pump
absorption filter

AQUA PLASTIC

Design to clean spray guns and accessories when working with waterborne products.

Allows to clean easily of the dirty water, mixing it with the flocculant through a pneumatic system. This way it separates completely the paint and pigment residues.

Robust and easy to use. Minimum maintenance.

Made of stainless steel.

TECHNICAL DETAILS

- > 1,500 x 500 x 660 mm
- > Weight: 40 Kg
- > Grid 275 x 385 mm
- > Deposit dimensions: 540 x 355 mm. (30 Litres)
- > Max. working unit weight: 5 Kg
- > Pump output 5 L/min
- > Working pressure: 7 - 10 bar
- > CE Certification
- > ATEX  II 3G



Doble 250 and accessories

DOBLE250

Meets all the advantages of the two most complete machines in the range Sagola: Sagola Aqua Plastic (water) and Sagola Compact 235 (solvent).

Designed with full equipment to offer an integrated solution offering optimum cleaning of guns which work with the new range of paints, waterborne basecoats and clearcoats and HS single stage paints.

Made of stainless steel.

Solvent area: Recirculation solvent automatic cycle (timer). Automatic final cycle of clean solvent. Manual cleaning brush. Final cleaning with clean solvent spraying. Auto-extraction of solvent vapors.

Water area: Allows to clean easily of the dirty water, mixing it with the flocculant through a pneumatic system. This way it separates completely the paint and pigment residues. Blowgun for drying.



Code

40000201

TECHNICAL DETAILS

- > 1,500 x 1,000 x 660 mm
- > Weight: 90 Kg
- > Sustainable load: 2 guns
- > Solvent area volume: 50 Litres
- > Water area volume: 30 Litres
- > Water/solvent pump flow: 5 L/min
- > Working pressure: 6 - 10 bar
- > CE Certification
- > ATEX II 3G

Atomizer venturi

Auto-extraction
of solvent vapors

Brush for washing the gun
exterior areas

Blowgun for drying the gun
interior areas

Gun with coupling to clean
interior areas

Filter mat for residues



Mat filter for waste and
pump absorption filter

Washer ACCESSORIES



Filter Mat (5 units)

Models: Aqua Plastic, Double 250

Code	Name
49000071	Filter Mat Kit - plastic large tank
49000115	Filter Mat Kit - metallic short tank



Optional hot water kit

Code	Model
40000219	Aqua Plastic

AquaCleaner Cleaning Agent

Code

40000205



AquaSeparator Floculant

Code

55550047



Air gun with blue hose

Code

49000089

Pump absorption filter

Code

49000489

Spray guns holding clips 2 units

Code

49000093

Brush for Water

Code

49000097

Water gun with green hose

Code

49000074

Extraction pipe

Code

49000495



Dry Tech Infra-red range Infra-red

Height adjustable

Short wave. Filtered light

Performance efficiency: 96.8%

Code

40000534

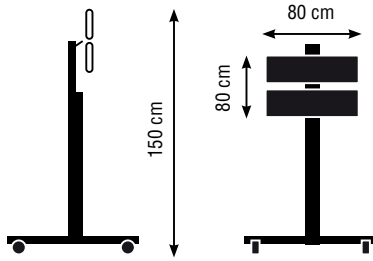

DT2

Ideal for retouches. Recommended for preparation tasks. Ideal for workshops with little space.

Screens may be placed in horizontal position. Screen positioning system with movement block.

Independent lamp power-up. Two lamps. Timer.

Single control system, compact and easy to use.



TECHNICAL DETAILS

- > Voltage: 220 V.
- > Frequency: 50/60 Hz.
- > Maximum power: 2 x 1,000 w.
- > Working min. distance: 50 cm.
- > Drying surface: 0.80 x 0.80 m.
- > Time setting: 0 - 60 min.
- > CE Certification

Compensation gravity by locking gas spring

Brakes on rear wheels

Code

40000533



With automatic distance sensors, the system alerts you when the emitter and panel are too close.

DT3

Independent lamp power-up. Screen positioning system with movement block.

Covers any part of the bodywork.

Short wave. Filtered light. Electronic control. Distance sensor.

Performance efficiency: 96.8%.



Electronic control



TECHNICAL DETAILS

- > Voltage: 220 V.
- > Frequency: 50/60 Hz.
- > Maximum power: 3 x 1,000 w.
- > Working min. distance: 50 cm.
- > Drying surface: 1 x 1.20 m.
- > Time setting: 0 - 99 min.
- > Temperature setting: 40 - 100°C
- > CE Certification



Shortwave infrared double-layer halogen lamps, specially designed for curing body paint.

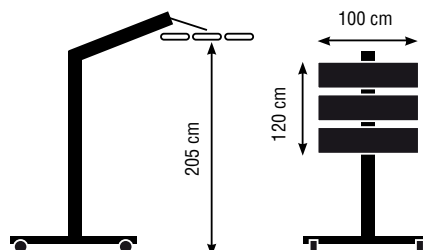

Infra-red **DT 6 and spare**



Electronic control



Shortwave infrared double-layer halogen lamps, specially designed for curing body paint.



With automatic distance sensors, the system alerts you when the emitter and panel are too close.

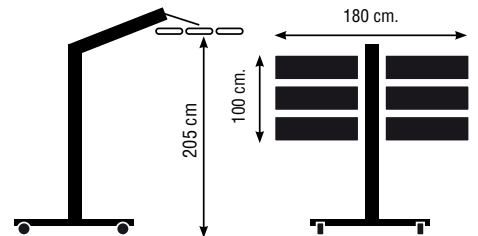

Compensation gravity by locking gas spring
 Brakes on rear wheels

DT 6

Independent lamp power-up.
 Screen positioning system with movement block.
 Covers any part of the bodywork.
 Performance efficiency: 96.8%.
 Short wave. Filtered light. Electronic control.
 Distance sensor.

Code

40000532

TECHNICAL DETAILS

- > Voltage: 380 V./3ph
- > Frequency: 50/60 Hz.
- > Maximum power: 6 x 1,000 w.
- > Working min. distance: 50 cm.
- > Drying surface: 1 x 1.80 m.
- > Time setting: 0 - 99 min.
- > Temperature setting: 40 - 100°C
- > CE Certification

Infra-red SPARES

Clamp
 DT2 Model



Code

49000773

Male lever
 All models



Code

49000777

Wheels with or without brakes

DT 3/6 Models

Code	Version
49000765	Without brake
49000764	With brake



Gas shock absorbers

With locking systems

Code	Models
49000763	DT3
49000762	DT6



Wheels with or without brakes

DT 2 Model

Code	Version
49000779	Without brake
49000778	With brake

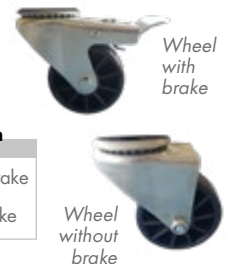

IR Lamp 1,100 w

Special for bodyshop

Code	Models
49000775	DT 3/6
49000776	DT2



Can and carton crusher

Can Crusher

Simple, versatile and
efficient

Code

40000314

TECHNICAL DETAILS

- > Dimensions: 510 x 540 x 1,460 mm
- > Working pressure: 8 bar
- > Power: above 1,700 Kg
- > Pneumatic safety system
- > Total weight: 185 Kg

Meets European Directive 98/37/CEE of 22 January 1998.

Significant space saving and cost reduction in waste management.

Designed to solve residue storage and disposal problems in places like bodyshops, industrial workshops, garages, etc.

Can Crusher

Greater load. Valid for cylindrical recipients up to 25 L.



Can and carton crusher

Functional and complete

Code

40000315

TECHNICAL DETAILS

- > Dimensions: 560 x 750 x 1,750 mm
- > Working pressure: 8 - 9 bar
- > Pneumatic safety system
- > Total weight: 225 Kg

Can and carton crusher

- Two accesses:
- > Upper: loads cardboard and paper.
 - > Lower: unloads cardboard, loads cans.

Reel of string at rear to tie the crushed bundles of paper and cardboard.



BODYSHOP
Trolleys and Racks
Trolleys
and racks

Rotating Panel Rack, Scissor Rack and Triple Mask

Rotating Panel Rack

Rack for bodyshop parts painting and sanding, very stable and fully adaptable.

Parts can be adjusted to the desired angle and height.

Lower tray for accessories.

Wheels with foot-brake for the turning system.

Code

40000251



Scissor Rack

Manageable and light

Holder for parts under repair or painting with sponge rollers to avoid damage to parts.

Curved legs designed for use on grid floors.

Code

40000250



Triple Mask

Very robust

Mobile masking paper roll holders with wheels to facilitate transport and laminated cutting edge for easy use.

Includes masking tape dispenser.

Code

40000238



TECHNICAL DETAILS

- > Dimensions: 35 cm, 60 cm, 90 cm.
- > Holds up to 3 rolls



Complete breathing equipment 4240 and Mask MP300

Face Mask 4240

Full breathing equipment

Maximum protection

Code	Version
15830101	US-Mil
15830102	Nitto

Does not include hose kit

Code	Version
15830103	US-Mil*
15830104	Nitto*

*Hose kit included: 10 m. hose and safety plugs, 1.5 m. of hose spray gun outlet.

Complete breathing equipment which includes: belt, pocket regulator and coalescent filter to remove low levels of moisture and oil. 10 meters of hose and safety plugs, 1,5 meter of hose spray gun outlet.

Preset regulator incorporating flow warning gauge with integrated high efficiency coalescent filter. Carbon filter to absorb vapour and odour.

The unit conforms to BS EN 1835, with a protection factor of 40. EC Certificate Number 58459, issued by BSi Product Certification.

89/686/CEE (EPI) approved.

Spares face mask

Code	Version
15880013	SPARE visor 10 units
15880015	Carbon FILTER
15880011	Acetate screen KIT



Hose kit

MP300

Mask with double charcoal filter against organic and solvent fumes

Facial housing of thermoplastic rubber

Elastic tape fastener

Code
14810301

SPARE Paint filter against organic and solvent fumes. 10 units.

Code
56418052

Double air inlet, allowing higher flow inhalations, making easier to breathe. Antiallergic. The mask is fitted with two carbon filters and a exhaling valve.

Suitable to be used in atmospheres contaminated with fumes and vapours with a boiling point over 65°C, like solvents and paints, offering a proper protection (with oxygen content in the air over 17% in volume).



Each of the built-in chemical filters of the mask is classified as "filter against fumes, A type, class 1" according to EN 141, and are also certificated separately.

Approved
EN 140:1998
EN 143:2000/A1:2006
EN 14387:2004+A1:2008

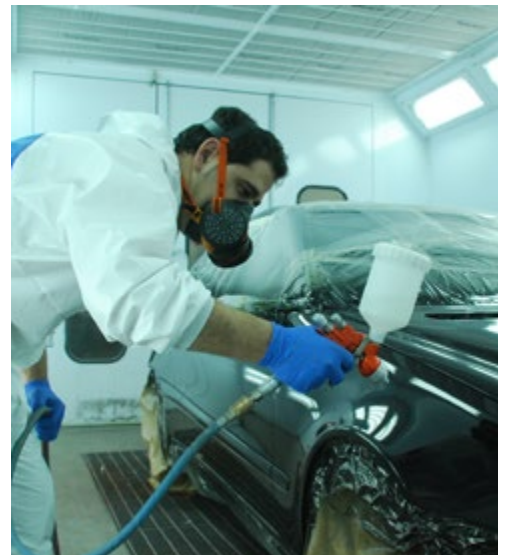

BODYSHOP
Personal protection
Breathing mask

**FFP2 mask
and anti-static dives**



M210 Model



M200 Model

FFP2 Mask

Self-filtering paper masks

Code	Version
40000263	M200
40000264	M210 with valve

For solid and liquid particles of low and medium toxicity. For use against non-ferrous metal dust, welding metal fumes, gasses and mists NOT INCLUDING materials such as lead, aluminium and manganese.

Double elastic tape. Flexible metallic strip for adjustment to nose, area.

NPF (nominal protection factor): 12 (concentration permitted in the atmosphere 12 times the TLV)

TECHNICAL DETAILS

M200 Model

> Comes in a 20-unit box.

M210 Model

> Comes in a 10-unit box.

> Built-in exhalation valve to make breathing easier.

Antistatic Coverall

Air ventilation system

Breathable

Water repellent and dirt-resistant

Code	Size	Size UE
40000523	XS	38/40
40000524	S	42/44
40000525	M	46/48
40000526	L	50/52
40000527	XL	54/56
40000528	2XL	58/60
40000529	3XL	62/64

Breathable panel in the back and underarms.

Adjustable hood with elastic band and velcro. Press-buttons neck closure. Elastic ankle and wrist.

2-way zip and flap fitted with 2 breast pockets, 1 inside pocket, 2 side pockets and a hip pocket.

Original Dupont Teflon coating (water repellent and dirt-resistant).

Silicone and lint free.

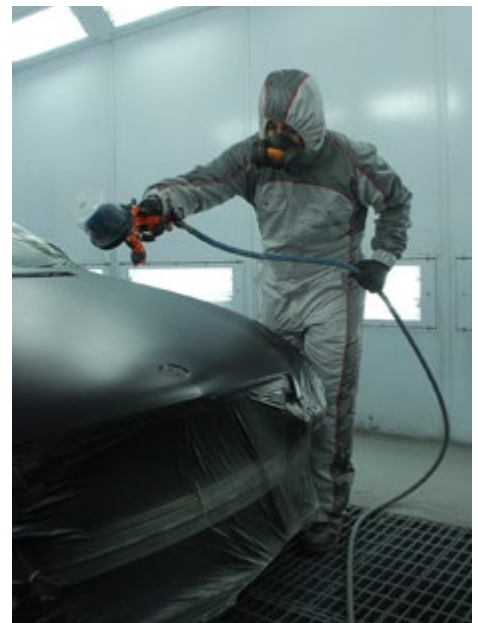

TECHNICAL DETAILS

> Material: 98% polyester, 2% carbon

> Standard EN1149: 1 Permanent antistatic

> PPE CAT. I

> Washable at 30°C or by chemical cleaning



Profiled composite casing:
comfortable and long-lasting

High performance sanders
Extremely high finish quality
Light, compact and powerful
No surface
contamination

Code L505

40000232

L505

Sander designed for grinding and
fast sanding

Code L252

40000231

L252

Sander for high
quality finishes

Code

40000230

L252R

Sander for fine
finishes



Composite impellers and
rotor Lubrication-free, works
without oil. Counterweight
system to guarantee smooth
operation.

Polisher

1200X

Electric angular polisher

Electronic

Code

40000507

Polishing beret

Code

49000109

Polishing plate

Code

49000110

Catalogue 2020

BODYSHOP

Sanding and
Polishing systems

Sanders & Polisher

"L" range sanders and
1200X Polisher

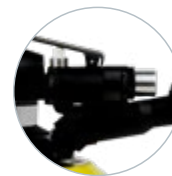

The air outlet is spins 360°

The air can be oriented and
kept away from the use

Fitted for extraction, it is
easily connected to central or
portable extraction systems

"L" range sanders have been designed for workshops where high performance and top quality finishes are demanded. If you are looking for scratch-free quality, you can trust the "L" range. Due to the lubricant-free design, there is no concern about substrate contamination. 0.2 HP motor, 12,000 r.p.m.

The **L505** is a pneumatic orbital sander with a 5 mm. oscillation designed for quick grinding down, with a good quality surface finish.

The **L252** is a pneumatic orbital sander with an oscillation of 2.5 mm. which ensures high quality finishes without leaving any kind of marks on the surface.

The **L252R** is a pneumatic orbital sander which ensures precision sanding and top quality finishing. It is ergonomic and light, perfect for those small retouches.

Sand disks

Code	Version
49000220	75 mm. ø sand disk (Velcro) L252R
49000501	152 mm. ø sand disk (Multiholes, Velcro) L252, L505



TECHNICAL DETAILS

- > Free speed: 12,000 r.p.m.
- > Air consumption: 220 L/min.
- > Air inlet: 1/4"
- > Min. size hose: 8 mm.

L505/L252

- > Plate size: 152 mm./6 inch
- > Oscillation L505: 5 mm. L252: 2,5 mm.
- > Net weight: 0.87 Kg.
- > Total length: 118 mm.

L252R

- > Plate size: 75 mm./3 inch
- > Oscillation L252R: 2,5 mm.
- > Net weight: 0.84 Kg.
- > Total length: 110 mm.

For polishing jobs on the bodyshop. Powerful and light.

TECHNICAL DETAILS

- > Voltage: 240 V/ 50 Hz
- > Power: 1,200 w
- > Disk: 180 mm
- > Adjustable speed: 600 - 3,000 r.p.m.
- > Weight: 3.2 Kg



BODYSHOP

Workshop complements

Paint preparation

Paper paint-strainers

Code	Version
40000253	190 microns
40000254	125 microns



Mixing cups

Cups with legs to prevent spillage. Reinforced top edge. Made of polypropylene. High resistance.

Code	Version	Units
40000508	400 ml.	200
40000509	650 ml.	200
40000510	1.300 ml.	200
40000511	2.300 ml.	175



Cup lids 100 units

Code	Version
40000512	400 ml.
40000513	650 ml.
40000514	1.300 ml.
40000515	2.300 ml.



Cup dispenser

Code	Version
40000517	400 ml.
40000518	650 ml.
40000519	1300 ml.
40000520	2300 ml.



Product mixers

500 pcs. / box
20 x 2 cm.

Code
40000499

200 pcs. / box
30 x 2 cm.

Code
40000320



Particle removal kit

Code
40000249



Booth anti-dust

Code
40000023

10 litres.
Product for protecting the walls, screens and glass of a spray booth.
> Protects from dust.
> Application with spray gun, roller or brush.
> Transparent and self adhesive layer.
> Clean product.
> Easily removable with water.



SAGOLA®



SAGOLA

65

ANNIVERSARY

1955-2020



MEXICO

Calle 2 · Número 5C · Bodega 6
Parque Industrial Benito Juárez
C.P. 76120 Santiago de Querétaro
(Querétaro) MÉXICO
Tel.: (+52) 442 388 5099
sagolamexico@sagolamexico.mx
www.sagolamexico.mx

COLOMBIA

Calle 30a · Número 6-22 · Piso 32
C.P. 110311 Bogotá COLOMBIA
Tel.: (+57) 1 - 7 43 68 30
sagolacolombia@sagolacolombia.co
www.sagolacolombia.co

SPAIN

Urartea, 6 · 01010
Vitoria-Gasteiz (Álava) SPAIN
Tel.: (+34) 945 214 150
sagola@sagola.com
www.sagola.com

SAGOLA 

